



Fiordland
Marine Guardians
Beneath the Reflections



Fiordland by Sea

A guide to the Fiordland
(Te Moana o Atawhenua) Marine Area



Acknowledgements

This guide was prepared by the Fiordland Marine Guardians, the Ministry for the Environment, the Ministry for Primary Industries, the Department of Conservation, and Environment Southland.

This guide would not have been possible without the help of those who provided information, advice and photos. Many people have contributed to writing the guide and their efforts and skill is acknowledged. To each of you we offer our sincere gratitude.

The Guardians acknowledge the relationship between Te Rūnanga o Ngāi Tahu, as tangata whenua, and Te Moana o Atawhenua.

Cover image: truestock, Vaughan Brookfield

Disclaimer

While reasonable efforts have been made to ensure this information is accurate and up to date, the New Zealand Government makes no warranty, express or implied, nor assumes any legal liability or responsibility for the accuracy, correctness, completeness, or use of any information that is available or referred to in this publication.

The contents of this guide should not be construed as authoritative in any way and may be subject to change without notice. Those using the guide should look for specific and up-to-date information from an authoritative source in relation to fishing rules, navigation, moorings, anchorages and radio communications in and around the fiords.

This guide must be read in conjunction with this disclaimer. Those who ignore this disclaimer do so at their own risk.

First published in October 2008 on behalf of the Fiordland Marine Guardians, Ministry of Fisheries (now the Ministry for Primary Industries), the Department of Conservation, MAF Biosecurity New Zealand (now the Ministry for Primary Industries), and Environment Southland by the Ministry for the Environment, Manatū mō te Taiao, PO Box 10362, Wellington, New Zealand.

Updated July 2017, June 2020, June 2021, June 2022, and June 2024.

© Crown copyright 2024

Publication number: ME 1248

ISBN:

978-1-991140-15-9 (print)

978-1-991140-16-6 (online)



Help keep Fiordland free of marine pests

Whether Fiordland is your backyard or you're visiting this iconic place, make sure you have a clean hull, clean gear and a clean vessel pass, to help us stop the spread of marine pests.

Visit www.es.govt.nz for more information and to get your clean vessel pass today.

Let's preserve Fiordland's natural beauty together.



Department of Conservation
Te Papa Atawhai

Contents

Introduction	4	Diving in the fiords	36
About this guide	5	General diving guidelines	36
The Fiordland Marine Guardians and the Fiordland Marine Area	6	Jet-skiing and water-skiing	37
The Fiordland marine environment	8	Waste disposal	37
A brief history	10	Discharging sewage	37
		General waste management	37
		Oil spills	37
		Management of commercial activities	39
Travelling in the fiords – Essential information	12	Radio communications	40
Preparing for your trip	13	General ship-to-ship communication	40
Seeking shelter from the weather	14	VHF radio repeaters	41
Moorings and anchorages	14	Maritime radio	41
Huts	15	Radio operators in the area	43
Biosecurity	16	Fisheries information and guidelines	46
Marine biosecurity	16	Managing Fiordland’s fisheries	47
Keeping marine pests out of Fiordland	22	Recreational fishing information and rules	49
Island biosecurity	25	Finfish	52
Marine Protected Areas	28	Shellfish	65
Marine reserves	28	Rock lobster (crayfish)	68
China shops	30	Commercial fishing regulations	77
Mātaitai	30		
Marine mammals and other protected species	31		
Marine mammals you may see in Fiordland	32		
How to operate around marine mammals	34		
Other protected species	35		

Fiord-by-fiord guide

Te Hokiāuau/Big Bay area	81
Piopiōtahi/Milford Sound	82
Papapounamu/Poison Bay	85
Te Hāpua/Sutherland Sound	86
Hāwea/Bligh Sound	88
Te Houhou/George Sound	91
Taitetimu/Caswell Sound	94
Taiporoporo/Charles Sound	96
Hinenui/Nancy Sound	98
Patea/Doubtful Sound fiord complex	100
Te Awa-o-Tū/Thompson Sound	104
Kaikiekie/Bradshaw Sound	105
Patea/Doubtful Sound	107
Te Rā/Dagg Sound	112
Te Puaitaha/Breaksea Sound and Tamatea/ Dusky Sound complex	114
Te Puaitaha/Breaksea Sound	118
The Acheron Passage and Moana Uta/ Wet Jacket Arm	120
Tamatea/Dusky Sound	122
Taiari/Chalky Inlet	128
Rakituma/Preservation Inlet	131

80

References and contact information

Sources of information	137
Suggested further reading	139
Recommended navigational charts	140
Contact information	141

136

Introduction

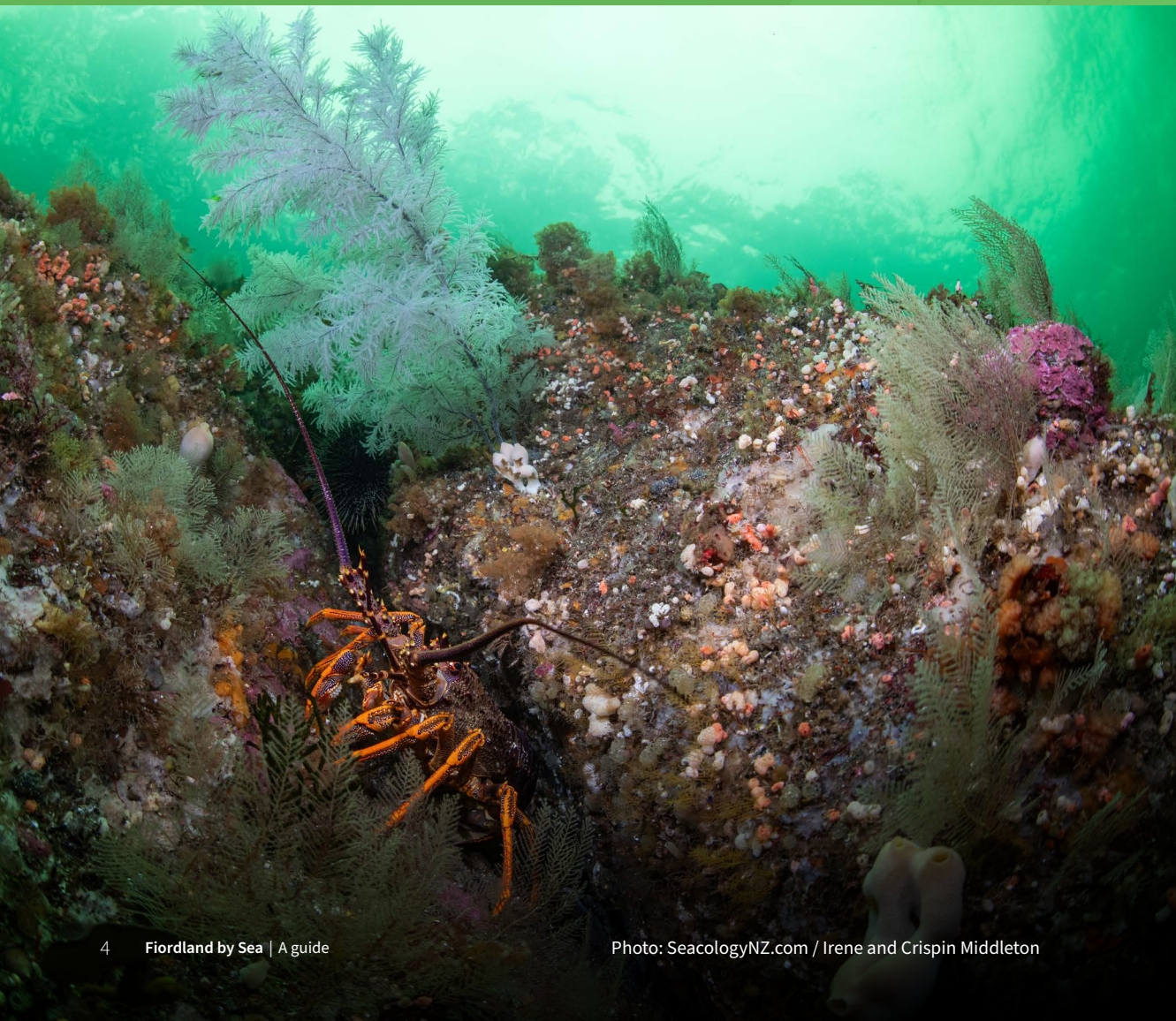

About this guide

Within this vast complex of 15 fiords bordering Te Wāhipounamu World Heritage Area and Fiordland National Park is the most spectacular boating, fishing and diving. The marine environment here is unparalleled anywhere in the world.

The Fiordland Marine Guardians have prepared this guide to help you safely navigate the area, but also to provide essential guidelines to protect this unique ecosystem and ensure a sustainable fishery.

This guide includes information on:

- **Clean vessel pass requirements**

It is a requirement under the Fiordland Marine Regional Pathway Management Plan that every vessel (regardless of size) is free from marine pests and holds a current clean vessel pass. See '**Keeping marine pests out of Fiordland**', page 22.

- **Fisheries rules and guidelines**

The fiords are under ever-increasing pressure from recreational fishing. To ensure sustainable use of finite fisheries resources, please adhere to all fishing limits and regulations. Download the **NZ Fishing Rules** app and see '**Fisheries information and guidelines**' section, page 46.

- **Marine Protected Areas and protected species**

There are 10 marine reserves in Fiordland, as well as a mātaītai reserve, several 'china shops' and no-anchoring areas. See '**Marine Protected Areas**', page 28. Fiordland is home to many protected marine species. See '**Marine mammals and other protected species**', page 31 for how to operate around marine mammals.

- **Pest-free island sanctuaries**

Within many of the fiords are pest-free islands that are protected sanctuaries for several endangered New Zealand native birds and other species. It is imperative that these islands remain free of rats, mice and stoats. For guidance on how to ensure your vessel is pest free, see '**Island biosecurity**', page 25.

- **Your safety**

Fiordland presents one of the most remote and potentially hazardous environments for boating. For guidelines on weather, radio communication and anchoring see '**Travelling in the fiords – Essential information**' section, page 12.

- **Local knowledge**

Information specific to each fiord, including navigation, anchorages, Marine Protected Areas and special rules, is provided in the '**Fiord-by-fiord guide**' section, page 80.

The Fiordland Marine Guardians and the Fiordland Marine Area

The origin of the Fiordland Marine Management Act, and the designation of the Fiordland (Te Moana o Atawhenua) Marine Area, began in 1995 with a group of commercial and recreational fishers, mana whenua and charter boat operators discussing their concerns about the state of the Fiordland fisheries and underwater environment. This gathering evolved into a more formal group including iwi, marine scientists, and environmental representatives, with the Ministry of Fisheries providing advice and facilitation.

Such is the extraordinary nature of Fiordland, discussions were complex. The group first had to identify present and future risks and come up with solutions to address those risks. Some solutions were so innovative they required special legislation, for example the protection of ‘china shops’.

Discussions on fisheries were based on a unique philosophy known as ‘gifts and gains’. What each group gave up or presented as gifts – a withdrawal from habitat or from customary fishing rights – was a gain to the wider Fiordland environment. These gifts and gains were carefully balanced among members of the group. Finally, in 2005, the Guardians’ work was officially adopted into law under the **Fiordland (Te Moana o Atawhenua) Marine Management Act**.

A strategy was designed specifically for Fiordland by those who knew Fiordland best, and then presented to the Government. This grass-roots approach to environmental management, embracing all stakeholders and cultural and scientific interests, has since been heralded around the world.

A major feature of the Act is the formal recognition of the Fiordland Marine Guardians, who are appointed by the Minister for the Environment. The Guardians not only advise on fishery matters, but also on biosecurity, resource management, compliance, monitoring and much more. The Guardians also promote cooperation and integrated management among the partner agencies – Ministry for Primary Industries (Fisheries and

Biosecurity), Environment Southland, Department of Conservation and Ministry for the Environment.

The Guardians’ vision is:

That the quality of Fiordland’s marine environment and fisheries, including the wider fishery experience, be maintained or improved for future generations to use and enjoy.

Within the Act is also the official designation of the Fiordland (Te Moana o Atawhenua) Marine Area, from the northernmost extremity of Awarua Point on the West Coast (the northernmost point of Te Hokiiauu/Big Bay) to Sandhill Point, Te Waewae Bay, in Southland, and extending out to sea 12 nautical miles off the Fiordland coast.

The Guardians look to the rūnaka of Ōraka-Aparima to provide leadership on behalf of ngā papatipu o Murihiku, in terms of kaitiakitanga – care and responsibility – across Fiordland and the Fiordland Marine Area. But it is only when we all understand and express kaitiakitanga towards this unique environment, that protection and restoration of the Fiordland Marine Area will be realised.

We sincerely hope you have a wonderful visit to the Fiordland (Te Moana o Atawhenua) Marine Area. Thank you in advance for doing all you can to protect this extraordinary and spectacular environment.

For more information on the Guardians, see www.fmg.org.nz.



The Fiordland marine environment

There is nowhere else on the planet that has a marine environment like Fiordland. The Māori expression 'ki uta ki tai', referring to the journey of water from the sky, over the land and down to the sea, perfectly reflects the nature of this marine area.

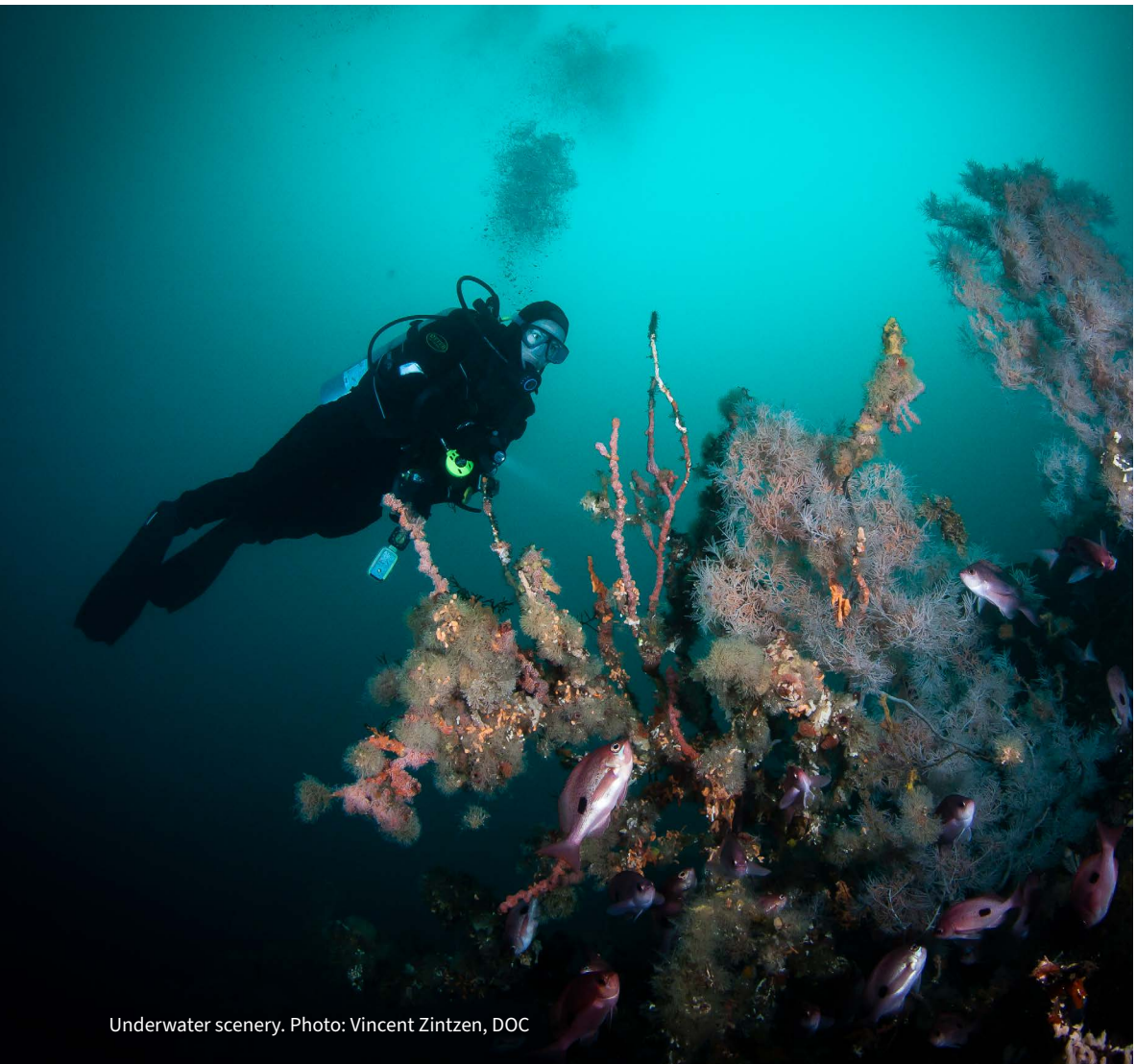

Underwater scenery. Photo: Vincent Zintzen, DOC

The creation of this underwater world of the inner fiord begins with the weather, Fiordland facing the brunt of what's known as the roaring forties, an often-relentless barrage of westerly weather systems and deluge-like rainfall (over 7 metres a year). But the rainfall works in combination with the extraordinary topography – steep-sided mountains, created from millennia of successive periods of glaciation, sometimes continuing underwater for hundreds of metres. The result is a ‘freshwater lens’ on the surface of the fiords down to 10 metres deep.

It's this freshwater layer that creates the magic. Often stained dark brown from tannins (the run-off through forest soils and debris), this freshwater lens effectively blocks the light from reaching the depths. Kelps, normally the basis of marine communities, do not grow well in low-light and low-wave energy conditions. Instead, deeper water species, like black coral, can colonise much shallower habitats – a phenomenon known as ‘deep water emergence’.

These inner fiords may appear vast, but the reality of this environment is that it is only a very thin ribbon along the sides of each fiord where there is enough light and habitat to support reef communities. Clinging to these rock walls is an incredible diversity of species – some anchored in place and others mobile, an amazing array of different forms and functions that are as beautiful as they are bizarre. Many of these species are yet to be scientifically described and named.

Diving here in the inner fiords is extraordinarily beautiful, but special care must be taken not to disturb or damage the slow-growing species like black or red corals.

For the topside angler, however, fishing in the inner fiord can be challenging – there are far fewer fish than on the outer coast, and what fish there are, are slow growing, their populations vulnerable to over-fishing.

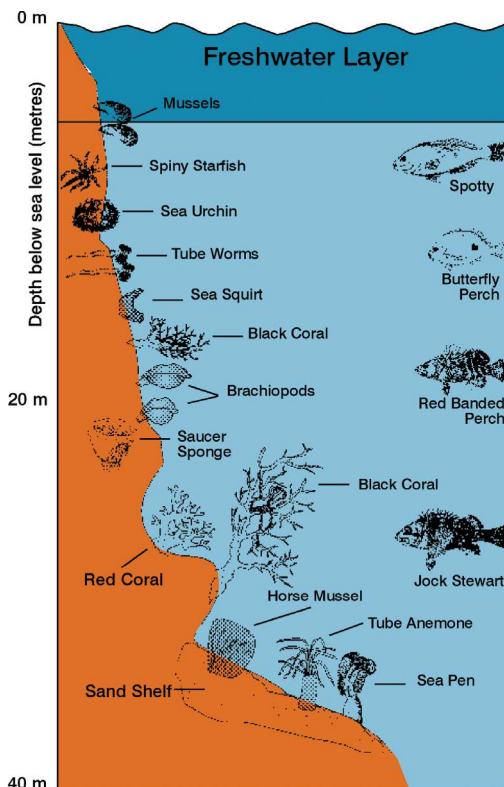

Typical fiord water column profile.

Conditions are very different in the entrances of the fiords and along the outer coast. Here, there is plenty of wave energy, light, far less influence of freshwater, and the marine life benefits from the nutrient-rich seawater from the Tasman Sea. Kelp forests flourish in this turbulent water. Algal growth fosters productive marine communities, and therefore provides far better fishing grounds.

This major difference between inner fiords and the entrances and outer coasts has a major impact on the species and the abundance of fish found in each habitat.

A brief history

It's difficult to comprehend the geological origins of Fiordland, a process that involved plate tectonics, rocks being hurled by volcanoes then metamorphosed, followed by successive periods of glaciation across millions upon millions of years. Scientists estimate the last ice age occurred just 16–18,000 years ago. Imagine every valley and fiord filled with ice, stretching miles out to sea, then slowly melting to the sea level we have now.



Storm brewing in Tamatea/Dusky Sound. Photo: Andris Apse

Easier perhaps, is to grasp the creation story of Fiordland as told by Māori, of the demi-god Tū-te-Rakiwhānoa, who decided to make this massif of land more habitable. Taking his adze, Te Hamo, he set to work chopping out a series of fiords. Working south to north, he had refined his technique by the time he reached Piopiotahi/Milford Sound.

Although this creation story might be myth, the story of Tamatea, the Māori explorer, adheres more closely to actual events, the narrative passed down through generations. It was Tamatea and his crew, on their ocean-going waka, *Takitimu*, who explored much of the coast of Murihiku/Southland (and some say even the Subantarctic) and were the first to explore what we now know as Tamatea/Dusky.

There are archaeological sites throughout Fiordland where Māori may have lived at least seasonally for hundreds of years, including urupā and burial caves, nohoanga/campsites, and places well known for inter-tribal battles.

Captain James Cook is widely regarded to be the first European to explore here, navigating past the Fiordland coastline in 1770 on HMS *Endeavour*, and returning in 1773 on HMS *Resolution*. The stories from his time in what he called Dusky Bay are fascinating, including the only encounters between Māori and Europeans to ever take place in Fiordland, fortunately all peaceably. One of the most important tasks for Cook and his crew here was to chart the greater part of Tamatea/Dusky Sound.

It was Cook's charts, carefully copied and sold from Greenwich when he returned to England, that spawned the next wave of European arrivals – the sealers and whalers. Among them were many colourful characters, leaving their legacy in the way of European placenames, but also the absolute desecration of the kekeno/fur seal and whale populations.

Tourism began several decades later, steamships plying the route from Dunedin around the many fiords to Piopiotahi/Milford Sound, also transporting stores and mail to whoever still lived in the remote fiords. These expeditions ended with the sinking of the *Waikare* in Tamatea/Dusky Sound in 1910, fortunately with no loss of life.

There was an attempt at a blue cod fishery in the early twentieth century (out of North Port, in Taiari/Chalky Inlet), but this was short-lived, being just too far from Bluff, the main port for processing. The rock lobster industry, however, boomed here after World War Two, and it was rock lobster fishers (or crayfishers) who were the main inhabitants of remote Fiordland for some decades, albeit living on a floating village of fishing boats.

The emergence of a new way to manage and care for Fiordland's marine environment is now also becoming part of the history of the area. The Guardians are trusted with the responsibility of ensuring that in the future, people will look back and respect the way that the community cared for this place.

The history of Fiordland and the Fiordland Marine Area is remarkable. We cannot do justice to the many stories that are laced throughout the land and sea and would urge you to consult the many publications listed in '**Suggested further reading**', page 139.

Travelling in the fiords – Essential information

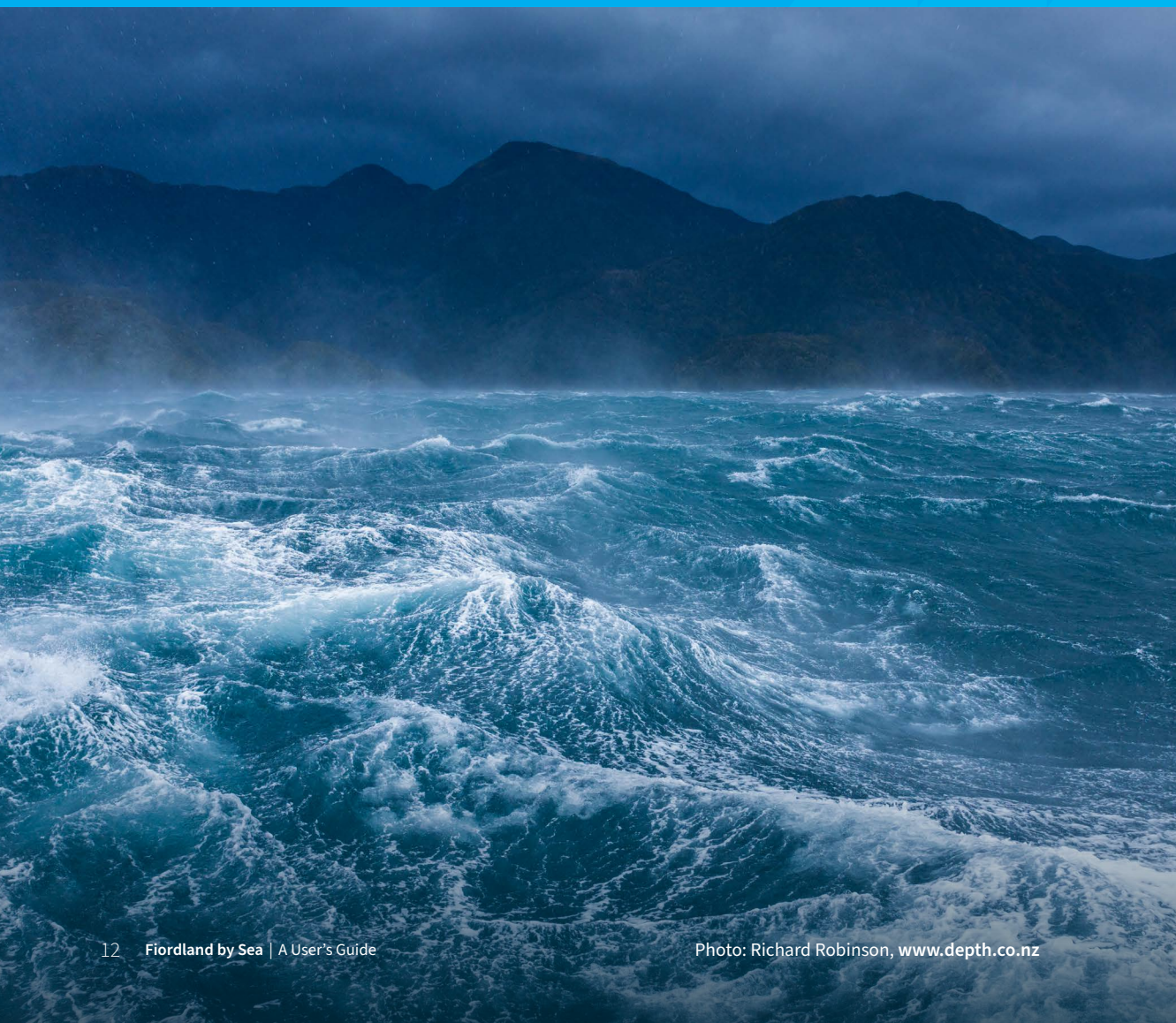

Preparing for your trip

Biosecurity

- **Ensure you have a current ‘clean vessel pass’** – a clean vessel hull is essential to make sure you aren’t spreading any marine pests into the pristine waters of the fiords. See **‘Keeping marine pests out of Fiordland’**, page 22).
- Make sure all fishing and dive gear and equipment (anchors and ropes) are clean and free of marine pests.
- Empty any on-board seawater and close off any live wells before you enter the Fiordland Marine Area.
- Check your vessel for signs of rats and mice to remove the risk of jeopardising Fiordland’s pest-free island sanctuaries.
- Do not transport live animals (fish or shellfish) into the Fiordland Marine Area.

Fisheries

- Fishing rules are subject to change. Get a copy of the current rules from your local Ministry for Primary Industries office, or look up online. You can download the latest fisheries rules and regulations using the **NZ Fishing Rules** app.
- Take this book with you.
- Ensure you have downloaded the **Mainland Catch** app so you can report your catch in Fiordland.
- Know where you can fish and how much you can take from an area. Fish for a feed, not for the freezer.

Safety

- Always carry up-to-date maritime charts (see **‘Recommended navigational charts’** page 140), and make sure any electronic navigational software is up to date.
- Fit a good quality VHF (very high frequency) aerial for improved radio communications.

- Ensure you have a plan for communication, which may include a combination of satellite internet, satellite phone and radio. See **‘Radio communications’**, page 40.
- Carry an emergency position indicating radio beacon (EPIRB). It is mandatory for commercial ships to carry a registered 406 MHz EPIRB. In a remote location like Fiordland, it’s also customary for recreational vessels to carry an EPIRB, and foolish not to.

Equipment

- Carry good quality anchoring gear – a high-holding anchor and at least 70 metres of rope or chain. Fiordland can be an unforgiving place with high winds and deep-water anchorages.
- Carry a spare length (about 15 metres) of garden hose for attaching to the water hoses that you will encounter throughout Fiordland.

Weather

- Know the weather forecast; be aware that it can change very quickly in Fiordland. Have a plan for accessing up-to-date forecasts when you’re in Fiordland via VHF or satellite internet.
- Know the right radio channel to receive weather forecasts for the area you are in.

General

- Bring plenty of fuel. Availability is very limited – you can only get fuel in Piopiotahi/Milford Sound and Patea/Doubtful Sound (which can run out).
- Carry sufficient stores for your trip through Fiordland. There are no shops.
- You must take all your rubbish out (crushed cans will take up less space than bottles in your rubbish bag).

Seeking shelter from the weather

The weather in Fiordland can be unforgiving, to say the least. The relative isolation here makes even the most minor of incidents potentially serious. You're a long way from help, and in extreme weather conditions there will be no help.

It doesn't take long for storms to hit the coast and when they do, the weather can change dramatically, exacerbated by the mountains. It is important to be aware of this, especially when you are out on the exposed open coast.

It is not unusual following heavy rainfall (or earthquakes) for forest debris to be in the water. This can present navigational hazards from semi-submerged logs. Significant run-off can also affect surface currents all the way out to the open coast.

During the summer months, in the area from Te Rā/Dagg Sound to north of Te Hokiauau/Big Bay, southwest day breezes can be a common occurrence. These winds can regularly be between 25–30 knots and can reach up to 35 knots at times.

During these periods, vessels travelling south should make their passage during early daylight hours (before 10.30am). From 11.00am onwards the 'day breeze' will have taken effect and the sea conditions from that time will worsen. This wind will generally not abate until after sunset.

With these weather conditions in mind, it is important to check there is a good weather window to get to your chosen destination and **plan to find a safe anchorage**. Be prepared to sit out bad weather and be mindful to select the appropriate anchorage for the conditions.

Moorings and anchorages

Despite the extensive coastline of the inner fiords, there are surprisingly few anchorages that provide shelter from all weather conditions and wind directions. Refer to the '**Fiord-by-fiord guide**' section for notes on each anchorage.

General guidelines on anchoring

Anchoring in Fiordland is quite different to many other areas of Aotearoa New Zealand. Some tips for anchoring in Fiordland are:

- visiting vessels should carry anchoring gear that is suitable for Fiordland. It should have **sufficient chain and rope or wire of at least 70 metres**, with a quality anchor of high holding capacity
- use all stern lines provided; however, a general check of the condition of these lines is advised, especially in little-used anchorages, as chafing will occur as the lines age
- **anchoring should always be done before dark** so stern lines and mooring lines can be seen, especially as these may be encrusted with mussels and partially sunken
- most anchorages in the northern fiords (north of Patea/Doubtful Sound) require a stern line
- when using stern lines in bad weather, keep as close to the shore as safety allows to shelter from sea conditions

- the anchorages described in the '**Fiord-by-fiord guide**' section are the main anchorages for use when shelter is required. During light winds, however, the heads of all fiords are suitable for anchoring. A note of caution: all heads of fiords can quickly change from around 30 metres to 1 to 2 metres in depth, mainly with mud banks, so caution should be taken while approaching to anchor
- most anchorages and stern lines are maintained by commercial fishers and tourism operators. VHF radio contact should be made with these local operators if they are in the area so anchorages do not become overcrowded during peak times. See '**Radio communications**', page 40
- carry up-to-date charts for the areas you plan to navigate. See '**Recommended navigational charts**', page 140.

Moorings

Many of Fiordland's recognised anchorages contain moorings, and these are often available for visiting vessels to use. However, the owners of some moorings have exclusive occupation rights, meaning that the visiting vessel may be asked to move on if use of the mooring is required.

It is up to each skipper to assess whether a mooring will have sufficient hold for their vessel.

Environment Southland (the regional council) is the authority over moorings and structures in the Fiordland Marine Area. Anyone considering installing a mooring should first contact Environment Southland to understand current rules and regulations. See '**Contact information**', page 141.

No-anchoring areas

Anchoring is prohibited in several areas in Fiordland which are home to particularly fragile species that would be damaged by an anchor or its swinging chain. Discrete no-anchoring areas are in:

- Clio Rocks (Hāwea/Bligh Sound)
- Precipice Cove (Kaikiekie/Bradshaw Sound)
- Te Awaatu Channel and Pendulo Reach (Patea/Doubtful Sound)
- Acheron Passage near Moana Uta/ Wet Jacket Arm
- Nine Fathom Passage (Tamatea/Dusky Sound)
- The Narrows (Te Awaroa/Long Sound)
- Awash Rock (Rakituma/Preservation Inlet).

See '**Fiord-by-fiord guide**' section for details.

Huts

There are coastal huts throughout Fiordland, as identified in the '**Fiord-by-fiord guide**' section. They are managed by the Department of Conservation in Te Anau. Use of the huts requires a hut ticket, which can be purchased from your local Department of Conservation office.

Biosecurity

Every vessel that navigates into Fiordland poses a risk or threat to terrestrial and marine ecosystems. It is **your responsibility** to do all you can to avoid bringing pests into the area, either those threatening underwater ecosystems or land-based native species.

Marine biosecurity

The unique marine environment in Fiordland is vulnerable to the introduction and establishment of harmful marine pests and diseases.

Each year hundreds of vessels enter the fiords for recreation or commercial purposes. These come from other regions of Aotearoa and around the world. Each of these vessels has the potential to bring in and deposit unwanted hitchhiking pests.

Biofouling – where pests attach themselves to vessel hulls, niche areas (such as sea chests), and on marine equipment (such as fishing gear) – is one of the most significant ways pest species spread from location to location. It would take just a few specimens of a foreign organism to be hidden in the fouling on a vessel and to fall off or reproduce within the Fiordland Marine Area, for a new population to establish. Marine pests can also travel to new destinations in onboard seawater such as bilge water, within live wells and ballast water.

Once established, marine pests can quickly spread in new locations, and can have serious effects on marine habitats, food chains, fish stocks, recreational activities, and commercial activities.

How to report pest sightings

If you see any of the pests below, or something else you consider unusual, please carefully note its location, and take a photo then report your finding at your earliest convenience.

If it's a species you think is already in other parts of Aotearoa, phone Environment Southland on 0800 76 88 45.

If you suspect it's new to Aotearoa, phone the Ministry for Primary Industries' Pest and Disease hotline on free phone 0800 80 99 66 or online at mpi.govt.nz/biosecurity.

Marine pests already found in Aotearoa

Styela clava



Styela clava. Photo: Northland Regional Council

Styela clava, a sea squirt, was detected in Auckland and Lyttelton in 2005. It is known to be present in many Aotearoa harbours including Otago Harbour. This organism can potentially compete with native fauna, particularly molluscs, for food. It appears in colonies as a leathery-skinned, tubular organism that can grow up to 16 cm long. It is easily transferred to new locations within biofouling on vessel hulls.

Undaria pinnatifida



Undaria pinnatifida. Photo: Kath Blakemore, DOC

The Asian seaweed *Undaria pinnatifida* (*Undaria*) is now widespread throughout Aotearoa harbours and coastlines, including Southland waters where it dominates reef communities. *Undaria* was found in Te Puaitha/Breaksea Sound in 2010 and Tamatea/Dusky Sound in 2022 and is currently under active management to contain it within these fiords.

Undaria can form dense forests on reefs where it outcompetes native species, and grows on any hard surface including rocks, ropes, wharf piles and vessel hulls.

Didemnum vexillum



Didemnum vexillum. Photo: Ashley Coutts, Cawthron

The invasive sea squirt, *Didemnum vexillum*, is present in Paterson Inlet, Rakiura/Stewart Island, Otago Harbour, and other parts of Aotearoa. It forms large colonies of yellowish, melted-wax-like mats that can drop from marine structures. Its appearance would be unsightly in a high-value ecological and tourism area such as Fiordland.

Sabella spallanzanii

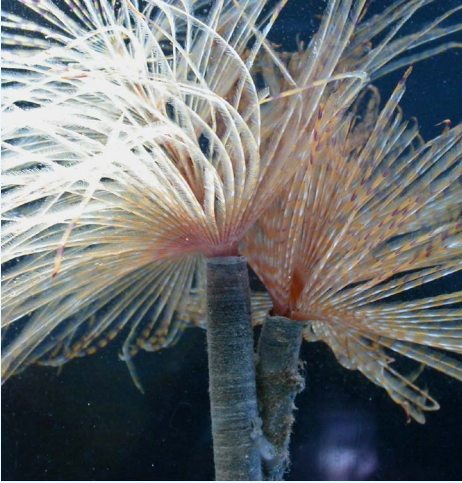

Sabella spallanzanii. Photo: Geoff Read, NIWA

Sabella spallanzanii (Mediterranean fanworm) is abundant in Auckland's Waitemata Harbour, Whangarei Harbour, and in Lyttelton Port and has been found in many other harbours including Otago Harbour.

It can form dense groups that could affect native species by competing for food and space. The presence of dense mats of this species could also have an impact on the aesthetics of an area like Fiordland for diving, potentially impacting on dive tourism activities.

The Mediterranean fanworm consists of a tube that is anchored to a hard surface, topped with a single spiral fan. They can grow up to 40 cm tall. The fans are white, banded with brown and orange, and the central stem is orange.

Caulerpa brachypus and *Caulerpa parvifolia*



Exotic caulerpa. Photo: Irene Middleton, NIWA

Exotic caulerpa seaweeds (*Caulerpa brachypus* and *Caulerpa parvifolia*) have been found in waters in the Hauraki Gulf and the Bay of Islands. Exotic caulerpa can spread rapidly, forming large underwater fields. It can compete with other species for space and upset the balance of local ecosystems. This presents a risk to recreational, cultural and commercial marine activities.



We cannot stress this enough: please ensure you have a clean hull and clean gear. These pests are only one boat ride away from Fiordland.

Marine pests unwanted in Aotearoa

The Ministry for Primary Industries maintains high border standards to prevent pests and diseases from entering the country. The Craft Risk Management Standard for Biofouling outlines biofouling and top-side requirements that international vessels must comply with before arriving in the country. Aotearoa is the first country in the world to have such a standard.

Below are five notifiable marine pests that are not known to be established in Aotearoa. These pests have been registered as 'notifiable', and **all sightings must be reported** to the Ministry for Primary Industries under the Biosecurity Act 1993.

There are many diseases of shellfish, fish and other marine species that we are fortunate not to have in Aotearoa. For example, abalone viral ganglioneuritis is a virus present in Australia that could seriously affect pāua populations here if it was introduced. If you know anyone arriving from overseas to visit Fiordland, remind them that border standards, such as requiring wetsuits and dive gear to be dry, and a prohibition on importing raw abalone meat, are important to prevent this disease spreading.

Chinese mitten crab – *Eriocheir sinensis*



Photo: MPI

European shore crab – *Carcinus maenas*



Photo: MPI

Asian clam – *Potamocorbula amurensis*



Photo: MPI

Northern Pacific seastar – *Asterias amurensis*



Photo: MPI

Caulerpa taxifolia



Photo: MPI

Fiordland's *Undaria* control programme

Undaria was first discovered in Te Puaitaha/Breaksea Sound in 2010. Between 2010 and 2017, Environment Southland, the Department of Conservation and Biosecurity New Zealand made a sustained effort to locally eliminate *Undaria* from Te Puaitaha/Breaksea Sound. However, in April 2017 *Undaria* was found to be widespread throughout Te Puaitaha/Breaksea Sound and in November 2022 it was detected in Tamatea/Dusky Sound.

The programme received a significant boost in funding from the Jobs for Nature | Mahi mō te Taiao programme in April 2020. The funding was aimed at nature-based employment and allowed local community members to be trained as scientific divers. The team of divers, managed by Environment Southland, removed about 45,000 kg of *Undaria* from Te Puaitaha/Breaksea Sound.

However, despite an innovative approach, many thousands of hours of work above and below water, and millions of dollars, the programme was unsuccessful in eliminating this pest from the area. Many lessons have been learned through this experience and they continue to be applied in Fiordland and around Aotearoa. We know that it is a lot easier and cheaper to prevent invasive species from coming into the area than it is to try and deal with an incursion. Hence, Fiordland has a marine pathway management plan that is focused on prevention.

We have also learned that the chances of eradication are higher if a marine pest incursion is detected early. In April 2019, a small incursion of *Undaria* was found on the bow line of the SS *Stella* (a wreck lying on its side on the shore) in North Port,

Taiari/Chalky Inlet. The three agencies immediately began a search and destroy approach at this site, and it seems this has been successful – Taiari/Chalky Inlet is once again *Undaria*-free.

Current control measures are geared towards containing *Undaria* within Te Puaitaha/Breaksea Sound and Tamatea/Dusky Sound, with a team of divers removing *Undaria* in Te Puaitaha/Breaksea Sound, the Acheron Passage, and the Bowen Channel to preserve long-term management options.

The Fiordland Marine Guardians and agencies urge boaties to be vigilant with hull, anchor and gear checking and cleaning to ensure *Undaria* is not carried from Te Puaitaha/Breaksea Sound and Tamatea/Dusky Sound to other parts of Fiordland. We ask divers to clean all dive gear after diving in these areas. See '**Te Puaitaha/Breaksea Sound and Tamatea/Dusky Sound fiord complex**', page 114 for more detailed information.

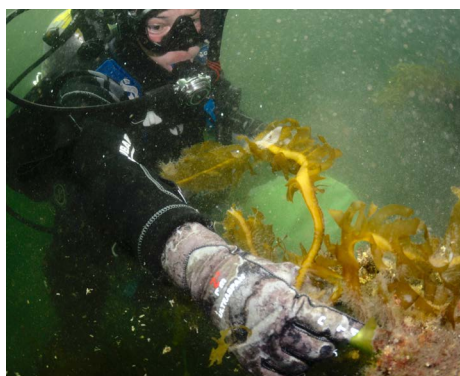

Diver pulling *Undaria*. Photo: Louise Bennett-Jones



PROTECT OUR PARADISE

Stop the spread of marine pests

biosecurity.govt.nz/boaties



Biosecurity New Zealand
Ministry for Primary Industries
Manatū Ahu Matua

Keeping marine pests out of Fiordland

The Fiordland Marine Regional Pathway Management Plan was established in 2017, pursuant to the Biosecurity Act (1993). It was the first of its kind in Aotearoa and aims to protect the Fiordland Marine Area from marine pests being carried in on local and visiting vessels.

Please adhere to the following rules, noting that contravention of the rules creates an offence under Section 154N(19) of the Biosecurity Act 1993:

- 1. The owner or person in charge of a vessel entering the Fiordland Marine Area must hold a current Fiordland clean vessel pass.**
- 2. The owner or person in charge of a vessel entering the Fiordland Marine Area must ensure the vessel complies with the following clean hull, clean gear, and residual seawater standards:**
 - ▶ **clean hull standard:** the hull and niche areas have no more than a slime layer and goose barnacles
 - ▶ **clean gear standard:** all marine gear and equipment on the vessel (including any equipment to establish new moorings) is visibly clean, free of fouling, free of sediment, and preferably dry
 - ▶ **residual seawater standard:** all on-board residual seawater has been treated or is visibly clean and free of sediment.
- 3. The owner or person in charge of a vessel entering the Fiordland Marine Area must keep records of the actions taken to meet the clean hull, clean gear, and residual water standards, and must provide those records to an authorised person on request.**

What can vessel operators do to help?

If you own or operate a vessel and intend to visit the fiords, or are about to relocate marine equipment such as buoys or ropes, please:

- **check** your vessel's hull and niche areas before entering Fiordland and if it is fouled, clean it (see below). Regular cleaning of your vessel's hull has the added benefit of fuel-efficiency cost savings
- **dispose** of any debris removed from the hull on land (ie, prevent it getting into the water)
- **check, clean** and thoroughly **dry** any mooring lines and buoys, crayfishing pots, kayaks, and any other marine equipment before using them in Fiordland waters
- **do not transport live animals** (fish or shellfish) from outside of Fiordland into the Fiordland Marine Area.

Cleaning your hull

If self-cleaning, once your vessel is out of the water, dislodge all plants and animals and dispose of debris in a bin that will go to a land-based rubbish dump. It is very important this debris does not go back into the water. Pay particular attention to:

- the earth plates, transducers, keels and stabilisers
- intakes and outlets
- propellers and shafts
- rudders, rudder recesses, rudder shafts and casings
- anchors, anchor chains and anchor wells.



The Southland Regional Coastal Plan prohibits the cleaning of vessel hulls within the Fiordland (Te Moana o Atawhenua) Marine Area.

Antifouling preparations

Using an antifouling paint correctly will stop fouling building up on your vessel's hull. Use a preparation that is suitable for the type of vessel and its use. Factors to consider are the:

- usual speed of travel
- amount of time your boat is kept at a mooring or berth
- material composition of your hull.

Follow the advice of the manufacturer and the supplying retailer.

Where to clean your hull before visiting Fiordland

There are haul-out facilities and slipways at most of New Zealand's marinas and at many harbours and ports. Marina operators will be able to advise you about cleaning facilities available in their region. Demand is often high, so it pays to book well in advance of your trip.

For a full list of haul-out facilities visit www.marinepests.nz/hauling-out.



You need to ensure your gear is clean before you travel into Fiordland, and when moving within and from Te Puaitaha/ Breaksea Sound and Tamatea/ Dusky Sound to other fiords.

How to ensure your gear is clean

In this context, gear includes:

- snorkelling/dive gear (eg, wetsuits, catch bags)
- fishing gear (nets, pots, buoys, ropes)
- anchoring gear (lines, anchors)
- small craft (kayaks, dinghys).

If lines, buoys and pots cannot be dried, disinfect them before coming into Fiordland waters from areas known to have marine pests present (such as Bluff and Rakiura/Stewart Island).

Please follow these simple steps:

Check

- Inspect your equipment for marine organisms (living or dead).
- Remove any marine growth and dispose of it in your rubbish bin.

Clean

Not all pests are visible – most have microscopic life stages that also pose a threat to Fiordland. You should clean your gear and equipment even if it looks clean.

Table 1 lists cleaning options you can use depending on:

- time available (eg, air exposure can take up to a month)
- access to treatment chemicals
- size of item(s), and the practicality of using the treatment methods on them
- sensitivity of equipment to chemicals and heat.

Residual seawater

Drain your bilge and any other residual seawater (eg, live wells) before entering the Fiordland Marine Area.

How to get further information about cleaning methods

Further information on vessel- and gear-cleaning methods and Fiordland marine biosecurity is on the Ministry for Primary Industries website: www.biosecurity.govt.nz/fiordland.

For further information on marine pests contact your local regional council, or visit the Ministry for Primary Industries' website: www.mpi.govt.nz/biosecurity.

Table 1: Cleaning options for gear

Soak	Spray/Wash	Dry
<p>Soak item(s) using one of these methods:</p> <ul style="list-style-type: none"> • Freshwater soak – for at least 72 hours. If soaking ropes, freshwater should be replaced after 12 hours. • Hot water soak – soak using water more than 40°C for 20 minutes.¹ • Dishwashing detergent soak – use a 5% dishwashing detergent and freshwater solution, and soak for 60 minutes. (5% solution = 500 mls of detergent into 10 litres of freshwater.) • Antiseptic soak – use a 1% Dettol antiseptic and freshwater solution, and soak for 60 minutes. (1% solution = 100 mls of Dettol into 10 litres of freshwater.) • Bleach soak³ – use a 2% bleach and freshwater solution, and soak for 30 minutes.² (2% solution = 200 mls of bleach into 10 litres of freshwater.) • Decon 90™ soak³ – use a 2% Decon 90™ and freshwater solution for 30 minutes. • Acetic acid soak – use a 5% acetic acid and freshwater solution or undiluted household vinegar, and soak for 10 minutes.² (5% solution = 500 mls of acetic acid into 10 litres of freshwater.) 	<p>For items too large or difficult to soak, spray following one of the methods below:</p> <ul style="list-style-type: none"> • 1% Dettol antiseptic and freshwater solution, then leave for 60 minutes. • 5% acetic acid and freshwater solution or undiluted household vinegar, then leave for 10 minutes. <p>When spraying an item, ensure you generously cover all surfaces.</p> <p>Hand-held sprayers can be purchased at a hardware store, garden centre, or in the gardening department of supermarkets.</p>	<p>For an item where chemical or freshwater treatment is not feasible, remove from water and thoroughly air dry for one month.</p> <p>Lay items out in a way that ensures all surfaces are completely dried.</p> <p>Prolonged air exposure is also an ideal complementary treatment for all items following soaking or spraying. The longer equipment is dried, the more effective the cleaning measures will be.</p>
<p>Note:</p> <ol style="list-style-type: none"> 1. Use hot water (more than 40°C) where possible as this dramatically increases its effectiveness. Temperatures exceeding 48°C should not be used on dive gear as some is temperature-sensitive. 2. Not recommended for dive gear as it may compromise the integrity of some plastics. 3. Follow correct handling precautions and ensure there is adequate ventilation; protective gloves and safety glasses are recommended. Dispose of cleaning solutions well above the high-tide mark and away from streams and rivers. 		

Island biosecurity

Please help protect our Fiordland islands. Many of these islands are pest-free sanctuaries, or bio-banks, for treasured rare or endangered plants and animals native to Aotearoa. Pukenui/Anchor Island is a particularly important predator-free sanctuary for endangered birds including kākāpō.

The work required to clear many of these islands has been led by the Department of Conservation and has been ongoing for over 35 years. Today, the many projects are also supported and assisted by several commercial operators and conservation trusts.

Predator control is tireless, back-breaking work in all weather. The arrival of one stoat or rat could undo decades of progress. **It is critical that you check your boat and equipment for pests (rats, mice or stoats).** Even if you are not going ashore, you can 'transport' the pests within swimming distance of these islands simply by anchoring nearby (and the animal slipping down the anchor chain).

Breaksea and Hāwea Islands were among the first in the world to have rats eradicated, and are now also a sanctuary for several endangered species. Secretary Island is currently the largest inshore island in Aotearoa to be free from rodents and possums. Many of these islands are home to rare species such as kākāpō, tīeke/South Island saddleback, mōhua/yellowhead, and kiwi pukupuku/little spotted kiwi.

Note: Breaksea Island is entry by permit only. However, there are numerous other islands where landings are permitted. Access rules may be subject to change so please obey all signage.

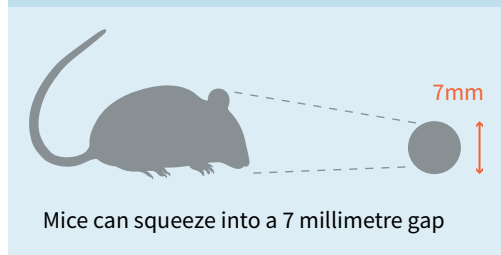
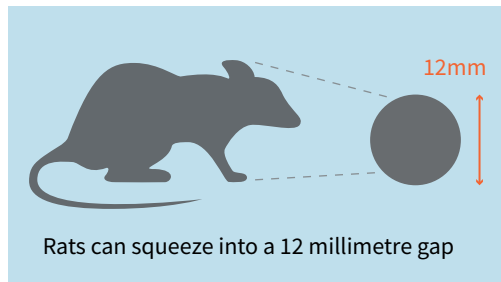

Ensuring these islands remain pest free by checking your boat and equipment is everyone's responsibility.

How you can help to protect treasured islands and your boat

Before you leave the mainland, and before you come close to any pest-free islands, please:

- check your clothes and footwear for stray seeds and pests, empty your pockets, and clean your shoes (including the soles)
- check your bags and other equipment, using sealable containers where possible (or seal with tape) or tie bags tightly to prevent any unwanted pests sneaking in
- ensure food is in sealed containers
- check your boat or kayak, including all obvious hideaways (like dinghies, kayak hatches, coils of rope), for unwanted stowaways – every time.

In addition to biosecurity, rodents can cause costly damage to your boat by chewing through electrical cables and can even cause vessel fires.

Other things you can do to help:

- install and regularly service rodent bait stations and traps on your vessel
- when your vessel is moored on the mainland, keep doors and hatches closed, and place screens over vents
- rodents can use mooring lines to board and leave vessels, so on multi-day trips use lines either adjacent to the mainland or to rodent-free islands, but not both
- use rodent shields on mooring lines
- leave your pets at home.

What to do if you find a pest

On the mainland, before leaving, humanely remove the pest and clean your gear again.

On your own boat or in your kayak:

- make sure the pest has been euthanised before you land
- don't throw rats or mice overboard as they can swim
- return to the mainland to euthanise the pest if you need to.

On a commercial boat, tell the crew what you have found and where it is.

Report any sightings of unwanted animal or plant pests on the islands to the Department of Conservation. See '**Contact information**', page 141.

Fiordland's pest-free islands

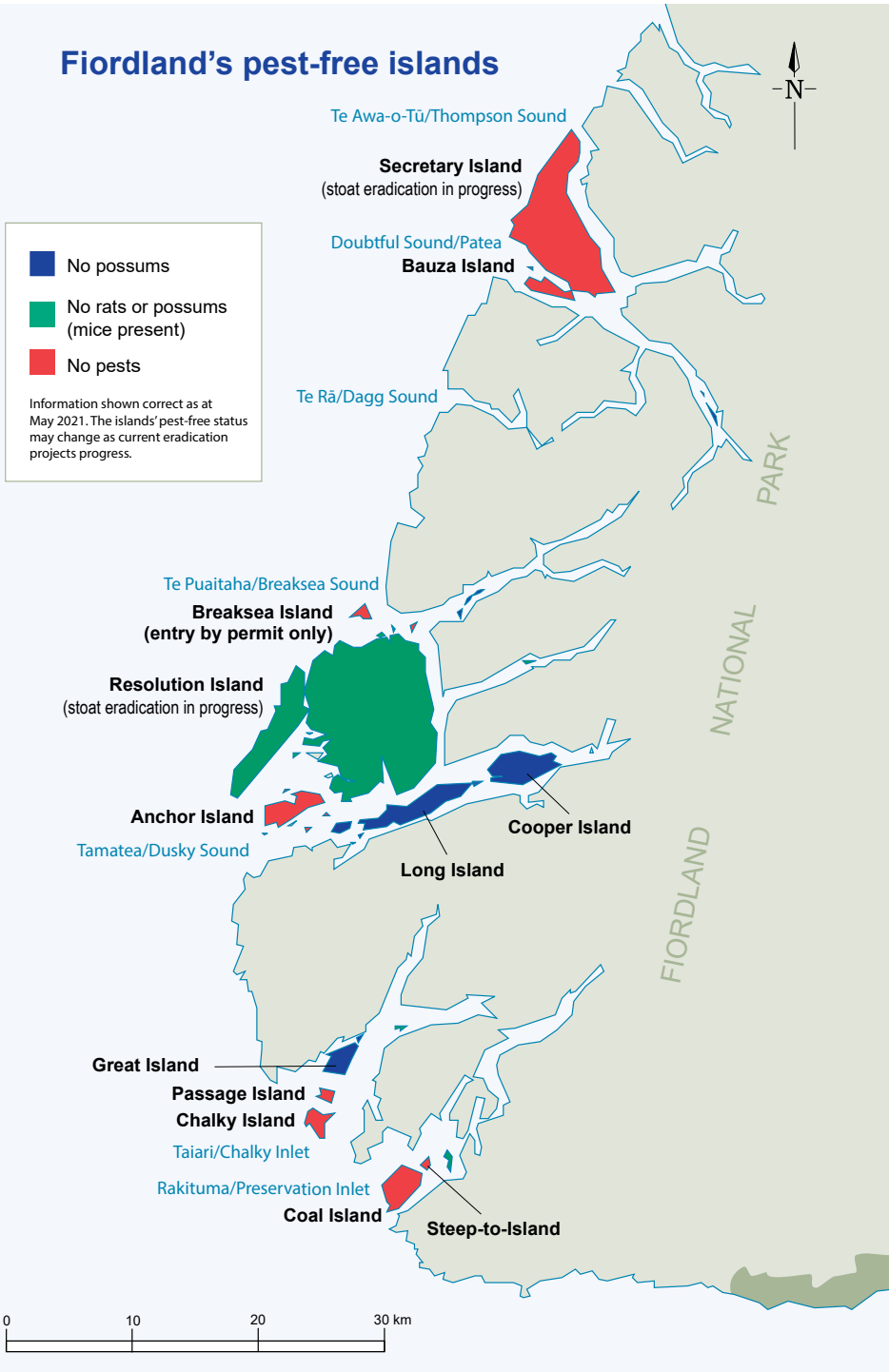

Marine Protected Areas

There are three kinds of protected areas within the Fiordland (Te Moana o Atawhenua) Marine Area: marine reserves, china shops and mātaītai.

Marine reserves

Marine reserves are Aotearoa New Zealand's most comprehensive tool in marine biodiversity protection. They may be established in areas that contain underwater scenery, natural features, or marine life of such distinctive quality, or that are so beautiful or unique, that their continued preservation is in the national interest. Marine reserves are managed by the Department of Conservation.

The first two marine reserves established in Fiordland were proposed by the Fiordland Fishermen's Association through its parent body the New Zealand Federation of Commercial Fishermen, and were formally established in 1993. They are the Piopiotahi (Milford Sound) Marine Reserve and Te Awaatu Channel (The Gut) Marine Reserve in Patea/Doubtful Sound.

In 2005, with the passing of the Fiordland (Te Moana o Atawhenua) Marine Management Act, eight new marine reserves were gazetted. Fiordland now contains 10 marine reserves, found from Piopiotahi/Milford Sound in the north to Rakituma/Preservation Inlet in the south. They range in size from 93 to 3,672 hectares, and include over 10,000 hectares of fiord marine habitat.

Similar sorts of rules apply in marine reserves as to national parks on land. Some activities are restricted or prohibited to protect the marine life in the area.

Enjoy your visit to the marine reserve, but note:

- all marine life is completely protected
- no fishing, netting, taking or killing of marine life is allowed
- no polluting, disturbance or damage is allowed
- no dredging, dumping or discharging of any matter is allowed
- no building of structures is allowed
- no removal of any natural thing from the marine reserve is allowed.

Recreational, educational and scientific activities are permitted and encouraged as long as they do not disturb or endanger the plant and animal life or natural features. In all marine reserves you may:

- kayak, dive, snorkel, swim and explore the shoreline
- anchor (with care, and only where allowed), and navigate through.

Rock lobster holding and pot storage areas

There is limited space and suitable depth for storing rock lobster pots inside some fiords. Four marine reserves have areas designated for commercial rock lobster fishers to store (in holding pots) live lobsters caught outside the reserve, and for storing rock lobster pots not in use at the time. All rock lobster catching pots and holding pots not in use and situated in these areas must have the doors open. These storage areas are not available for use by recreational fishers.

You can find more information on each individual marine reserve in the '**Fiord-by-fiord guide**' section.

Te Poupou o Te Rua o Te Moko – marine reserve markers

Fiordland’s marine reserves are marked by distinctive carved wooden or stainless steel poupou – Te Poupou o Te Rua o Te Moko. Each poupou stands as kaitiaki of the marine reserve and is symbolic of Māori ancestral connections to the area. These poupou are individually named after a deity, an explorer, whānau and whānui who left their mark on the area previously, and commemorate their stories, ensuring they are shared with generations of visitors to the area.

After several years of planning by the Fiordland Marine Guardians, the Department of Conservation, and local iwi from the Te Rūnaka o Ōraka Aparima (the mandated iwi kaitiaki) on behalf of the wider Te Rūnanga o Ngāi Tahu, the poupou were welcomed to the area.

The Guardians commissioned the late Bubba Thompson, from Te Rūnanga o Awarua, to design and carve the first wooden poupou that were unveiled in a special ceremony at the Kahukura (Gold Arm) Marine Reserve in Taiporoporo/Charles Sound in 2014.

Many of the wooden poupou have since been replaced with custom-made stainless steel poupou as a more durable alternative to withstand the harsh conditions.

The poupou mark the marine reserves throughout Fiordland, and it is hoped they will stand as kaitiaki for many years to come. The Guardians trust you enjoy these poupou as a reminder and acknowledgment of those who have come before.

The production and installation of the poupou was jointly funded by Te Rūnanga o Ngāi Tahu, The Department of Conservation and Meridian Energy.



Bubba Thompson. Photo: Peta Carey



Wooden poupou. Photo: DOC

China shops

In addition to establishing marine reserves, the Fiordland Marine Management Act gave recognition to other high-value areas throughout Fiordland. These areas are designated ‘china shops’. China shops are discrete areas noted for their abundance or diversity of animal communities, plant communities, a mixture of both, or areas containing key individual species.

Due to the nature of the fiords, the china shops are often located where the current is strong, where fiords change direction sharply, or in the narrow channels around islands. Five of these china shop areas have been designated as no-anchoring zones in an effort to protect their special and fragile habitats. In others, there are restrictions on potting, as pots can damage sensitive species such as corals and sea pens.

You can find more information on the specific locations of china shops in the ‘**Fiord-by-fiord guide**’ section.

Mātaimitai

Mātaimitai reserves are developed and managed by tangata whenua. They recognise and provide for the special relationship between tangata whenua and their traditional fishing grounds, including non-commercial customary and recreational fishing. Mātaimitai reserves may have bylaws that tangata kaitiaki use to manage fishing. Bylaws and regulations need to be approved by the Minister for Oceans and Fisheries.

The Waitutu Mātaimitai Reserve, on the south coast of Fiordland encompasses approximately 2.08 sq km bounded between the western side of the Wairaurahiri River mouth and the eastern side of the Crombie Stream mouth and extending seaward 450 metres (0.24 of a nautical mile) from the mean high-water mark.

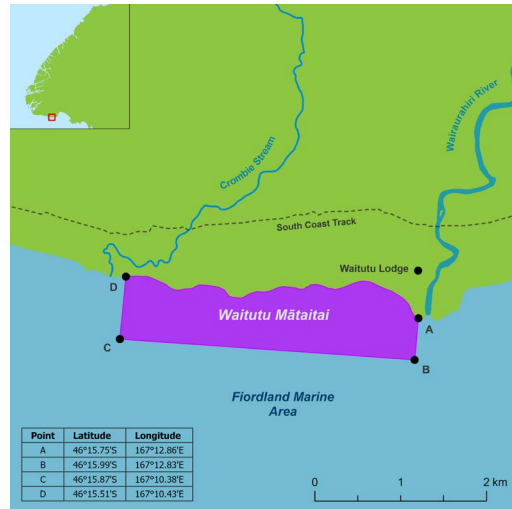

Waitutu Mātaimitai Reserve.

This customary fisheries reserve was established in 2014. Appointed tangata tiaki/kaitiaki (guardians), nominated by the mana whenua, manage all fishing and gathering within the reserve through mātaimitai reserve fishing bylaws. The remote Waitutu area remains an important mahinga kai (food resource) for Ngāi Tahu whānui, and current management measures are designed to replenish the area for the future benefit of mana whenua and visitors.

The bylaws for this mātaimitai are outlined on **page 51**.

Marine mammals and other protected species

Fiordland's waters are home to, or are visited by, a diverse range of marine mammals. Over one third of all marine mammal families have been recorded in Fiordland, making it a 'hotspot' for several species.

The growing public interest in marine mammals and the expansion of sea-based tourism present new threats to these mammals. These threats include boat strike, noise pollution, harassment, displacement, and separation of mothers and their young.

Dolphins are inherently playful. But please be aware that every time a dolphin is distracted by a boat's wake, it comes at a cost to the animal's wellbeing, particularly if they're breeding and need to feed. Note that the Fiordland bottlenose dolphin is classified as Critically Endangered by the International Union for Conservation of Nature (IUCN).

By contrast, some marine-mammal species have rebounded dramatically since the whaling and sealing eras. It's a good news story – the population of Fiordland kekeno/fur seals is now considered almost as prolific as it was before the sealing industry began, and there has been a significant increase in sightings of almost all whale species along the Fiordland coast.

The Department of Conservation keeps a sighting database of marine mammals that have been seen in Fiordland and is always keen to hear about any unusual sightings you may have. Please contact the Te Anau Department of Conservation office to report your observations when you visit the fiords, but be mindful of how you behave around marine mammals.

Marine mammals you may see in Fiordland

Bottlenose dolphin (*Tursiops truncatus*)



Photo: Chloe Corne, DOC

Archetypal dolphin, up to 4 metres long with a grey body. Found in many of the fiords, especially Patea/Doubtful Sound and Tamatea/Dusky Sound where there are two distinct populations needing our protection (see 'Fiord-by-fiord guide' section, **page 102**). The Fiordland bottlenose dolphin is classified as Critically Endangered by the IUCN.

Dusky dolphin (*Lagenorhynchus obscurus*)



Photo: Richard Kinsey, DOC

Smaller dolphin up to two metres long, with a black back and black and grey dorsal fin. The throat and belly are white and there are two obvious patches of grey on the flanks. Found mainly on the outer coast but occasionally found in the fiords.

Common dolphin (*Delphinus delphis*)



Photo: Nathan Pettigrew

Similar in size and colouration to the dusky dolphin. The most noticeable difference is they have a longer more slender beak and lack the obvious stripes on their flank. As with dusky dolphins, they are found mainly on the outer coast although one common dolphin lives with the resident pod of bottlenose dolphins in Tamatea/Dusky Sound.

Kekeno/New Zealand fur seal (*Arctocephalus forsteri*)



Photo: Richard Kinsey, DOC

Dark grey/brown, pointy nose, long whiskers, males larger than females, growing up to 180 kilograms. Found throughout the Fiordland coast.

Tohorā/Southern right whale (*Eubalaena australis*)



Photo: Don Goodhue

Large black whale distinguished by arched mouth line, white markings on the head, and the lack of a dorsal fin. As the population recovers, they are expected to begin using sheltered bays in Fiordland to calve, as they once did before the whaling industry of the early 1800s. Please contact the Department of Conservation as soon as possible if you see one, with details of the location and number of animals observed. Individuals can be identified by the patterns of white markings, so a photograph would be gratefully received.

Paikea/Humpback whale (*Megaptera novaeangliae*)



Photo: DOC

Large whale with very long narrow flippers and a series of round protrusions on the head and lower jaw. Humpback whales are becoming more common around Fiordland as populations rebound from whaling. Fiordland forms part of the humpbacks' migratory route between the winter breeding grounds in Australia and the summer Subantarctic feeding grounds. Recent studies show most humpbacks that visit Fiordland are part of the population from the east coast of Australia. Individuals can be identified by markings on the underside of their tail fluke.

How to operate around marine mammals

All marine mammals are protected by law under the Marine Mammals Protection Act 1978 and the Marine Mammals Protection Regulations 1992. These regulations aim to minimise the threats to marine mammals by setting out the appropriate behaviour for all people when boating around them.

In addition, there is a special Marine Mammal Code of Conduct in Patea/Doubtful Sound, including dolphin protection zones, see 'Patea/Doubtful Sound fiord complex', page 100.

Please be aware of your responsibilities if you come across marine mammals in the fiords. Guidelines are provided, but it is up to you to behave in a way that doesn't disturb or harass them.

Be particularly careful of groups of marine mammals with young calves, as they are especially vulnerable to disturbance.

Kekeno/fur seals on land

- Give seals space. Where practicable, stay at least 20 metres away.
- Avoid coming between fur seals and the sea.
- Keep well away from seal colonies during the mating season (December/January), as bull seals can be very aggressive.

Marine mammals in the water

- Ensure that you travel no faster than idle or 'no wake' speed within 300 metres of any marine mammal.
- Approach whales and dolphins from behind and to the side.
- Do not circle them, obstruct their path, or cut through any group.
- Keep at least 50 metres from whales (or 200 metres from any large whale mother and calf or calves).

- Swimming with marine mammals in Fiordland is not recommended and it is not permitted to swim with whales.
- Avoid approaching closer than 20 metres to seals and sea lions hauled out on shore.
- When leaving marine mammals, idle slowly away. For dolphins, speed may be gradually increased to out-distance them but should not exceed 10 knots within 300 metres.

Simple rules for boaters when interacting with whales and dolphins

Don't travel faster than idle or 'no wake' speed within 300 metres



No more than 3 vessels within 300 metres



Do not obstruct their path. Approach from a parallel/slightly rear direction



Do not swim with dolphin pods containing juveniles



Stay 50 metres away from any whale or orca



Stay 200 metres away from any baleen/sperm whale with a calf

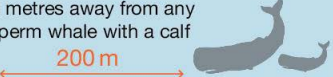

Do not swim with whales or orca



www.doc.govt.nz
New Zealand Government



Department of Conservation
Te Papa Atawhai

Other protected species

In addition to marine mammals, there are many species of seabird, fish and invertebrate that are protected under the Wildlife Act 1953. These include residents of the Fiordland Marine Area, as well as some that regularly visit Fiordland.

In particular, note that it is prohibited to take or possess the following species:

- corals, including black coral, red coral, and sea pens (*marine cnidarians*)
- white pointer sharks (*Carcharodon carcharias*).

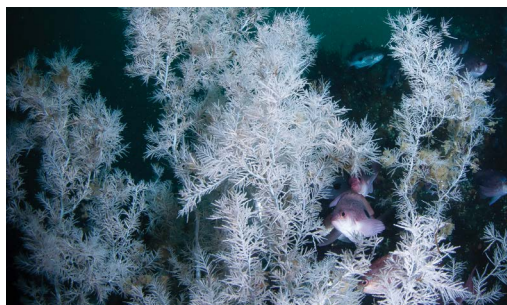

Black coral. Photo: Vincent Zintzen / Red coral. Photo: Malcolm Francis, NIWA / Sea pens. Photo: Irene Middleton

Tawaki/Fiordland crested penguin (*Eudyptes pachyrhynchus*)

Fiordland is home to one of the world's rarest penguins – the tawaki/Fiordland crested penguin (or Fiordland penguin). These iconic seabirds are endemic to Aotearoa, and inhabit coastal areas in South Westland, Fiordland and Rakiura/Stewart Island.

Tawaki can travel hundreds of kilometres into the Tasman Sea to feed. Unlike other crested penguin species, they do not form colonies. In Fiordland, they nest throughout the coastal rainforest during the breeding season from July to November and are often observed swimming inside the fiords. Tawaki pairs tend to produce two eggs at a time, but the survival of the chicks depends on a variety of factors including parent survival (they're vulnerable to being caught in fishing nets), food availability, predation by introduced species, and disease.

It is extremely challenging to obtain accurate population estimates, and there is also uncertainty about whether the population is stable or not. The current estimate is 12,500–50,000 adults.

Tawaki are listed by the IUCN Red List as 'Near Threatened', with a declining population trend. To learn more about tawaki and the research underway, visit www.tawaki-project.org.



Fiordland crested penguin (tawaki). Photo: Barry Harcourt

Diving in the fiords

The variety of diving and the abundance of marine life help make Fiordland one of the world's premier dive locations. Many of Fiordland's marine habitats are fragile, delicate and contain long-lived, slow-growing organisms. When diving in the fiords, please respect and take special care to look after this extraordinary environment.

Fiordland is a very long way from medical facilities. Its distinctive marine environment creates unique diving conditions, but can also be challenging. There is low light, a cold freshwater layer, steep walls, and strong tidal currents in some places. It is particularly important that divers are appropriately trained and plan their dives carefully, including accounting for any travel to altitude following diving (including back through the Homer Tunnel or over the Wilmot Pass).

It is recommended that boats carry medical oxygen for diving emergencies.

General diving guidelines

Some general guidelines for diving in Fiordland are:

- Dive carefully and respect all underwater life. Find out about the species you are looking at and respect them in their home. Avoid contact with marine life on the sheer rock walls and sea floor, as most of the invertebrate species encountered are extremely fragile.
- Control your buoyancy and be aware of yourself and your equipment, especially your fins. Try to keep your fins from dragging on bottom-dwelling animals and plants.
- Dive from a drifting boat, or use a mooring if one is available; avoid anchoring.
- Look, but do not touch. Handling will often create unnecessary stress to organisms.
- Resist the urge to collect souvenirs or trophies. It is illegal to take or harm protected species. Red and black coral are protected under the Wildlife Act.
- Be aware of, and adhere to, fish and crayfish limits. Remember that the limits in Fiordland are different inside and outside the fiords and are different from elsewhere in Aotearoa. See '**Fisheries information and guidelines**' section.
- When collecting shellfish, be mindful of the way you take them off the rock; they are easily damaged. Note that it is unlawful to take any pāua using underwater breathing apparatus. This does not include snorkels.
- Ideally, aim to measure shellfish before surfacing, leaving undersized shellfish where you found them. Throwing shellfish overboard from a vessel invariably leads to them lying upturned on the sea floor, reducing their chances of survival.
- Snorkelling and diving equipment from outside of Fiordland could be infected with unwanted marine pests. When coming to the area disinfect your gear or make sure it is bone dry, to minimise the spread of pest plants or animals. See '**How to ensure your gear is clean**', page 23 for a guide to cleaning your gear.
- Make the most of activities that have no impact, such as observation and photography.

Jet-skiing and water-skiing

Jet-skiing and water-skiing are prohibited, under rule 16.3.1 of the Regional Coastal Plan for Southland. The rule specifically prohibits water-skiing, parasailing or the use of personal watercraft (jet skis) in the Internal Waters of Fiordland. These activities are regarded as inappropriate in an area where peace and quiet is a significant value.

Waste disposal

Discharges of contaminants into the sea can have a range of effects, even when in small amounts. Similarly, throwing things over the side can cause ongoing damage. It is vital that you manage discharges and other waste from your vessel, to avoid polluting the fragile Fiordland marine environment.

Discharging sewage

If you have a holding tank fitted, use land-based, pump-out facilities for sewage, where provided. Note that in Fiordland there is only one such facility in Patea/Doubtful Sound, and it is only available at the discretion of the local operator. See '**Patea/Doubtful Sound**', page 107.

If you don't have a holding tank, or have to empty your holding tank at sea to discharge sewage, the Resource Management (Marine Pollution) Regulations 1998 stipulate that you must be:

- more than 500 metres from shore and in water over 5 metres deep
- more than 200 metres from a marine reserve
- not near other boats, swimmers or other people using the water.

It is best practice to discharge sewage well outside the fiords.

General waste management

Some useful tips:

- Be responsible when handling hydrocarbons (including petrol, diesel and heavier fuel oils).
- Take out with you what you take in.
- Retain all non-biodegradable rubbish on board and bring this out with you when your trip in Fiordland has finished.
- Cans are a good alternative to bottles as they can be crushed afterwards.
- Be mindful of discarding vegetable matter, fish frames, and food scraps in enclosed shallow anchorages where tidal flushing is minimal.

Oil spills

All ships should prevent spills, but in the case of any minor hydrocarbon spill, ships should have their own plan to clean up using absorbent pads.

Maritime New Zealand and Environment Southland have a comprehensive oil spill contingency plan for dealing with this threat in Fiordland.

If a spill occurs and the clean-up is beyond the capability of the ship, contact Maritime New Zealand through the Rescue Coordination Centre on the 24-hour emergency number, 0508 472 269 (note that Environment Southland will respond in the first instance).

If at sea, call the Maritime Operations Centre on VHF Channel 16, and they will pass the information on to the Rescue Coordination Centre and to Environment Southland. If Channel 16 is not accessible, call one of the radio operators listed in '**Radio communications**', page 40.

In the case of larger spills, the response may be escalated, and Environment Southland or Maritime New Zealand will manage the response.

If you see a source of pollution in Fiordland waters, including any oil spill, contact Environment Southland on the Southland area 24-hour pollution hotline, 0800 SOUTHLAND (0800 76 88 45), or via Channel 16, as above.

The Great Fiordland Coastal Clean-up

In 2003, the Great Fiordland Coastal Clean-up began. This ambitious project was the brainchild of local helicopter pilot Wayne Pratt and fisherman Peter Young (an original Guardian). The first clean-up took five years to complete. Groups of volunteers scoured Fiordland's 450 km of coastline from Te Hokiua/Big Bay in the north to Te Waewae Bay in the south over a series of week-long trips.

The estimated haul of rubbish collected in the first complete clean-up was between 500–600 cubic metres and was mainly lost fishing gear, pelagic rubbish, and a large number of plastic bottles as well as the occasional television, wheelie bin and even a motorbike.

Since the first survey in 2003, the clean-up has revisited well-known collection points

throughout Fiordland and has been driven by the original passionate people along with others like Southland tourism operator Joyce Kolk. The southern part of the coast from Tamatea/Dusky Sound to Rakitima/Preservation Inlet has now been revisited three times.

The surveys would not have been possible without the amazing support of the volunteers, the financial contribution from helicopter companies, the fishing industry, government agencies, and a huge number of local businesses. In 2017, the Southern Coastal Charitable Trust was established to manage and coordinate these clean-up efforts with the area expanded to include the west coast of Rakiura/Stewart Island.



The Great Fiordland Coastal Clean-up. Photo: Pete Young

Management of commercial activities

Commercial tourist operators require consents to operate in the Fiordland Marine Area and the Fiordland Marine Guardians are considered an affected party in the consenting process, meaning they can make submissions on individual applications for consent.

Environment Southland (the regional council) issues resource consents in line with the Southland Regional Coastal Plan, which contains rules relating to surface water activity (eg, tourist vessels), and moorings and structures (eg, wharves).

Additional concessions, consents and permits may also be required from the Department of Conservation or Fisheries New Zealand if the operator wishes to offer activities such as marine mammal viewing or recreational fishing.

Cruise ships are collectively managed under a Deed of Agreement with Environment Southland. This deed establishes where cruise ships can travel in the fiords, restricts the number of ships in the Internal Waters and sets standards for marine biosecurity, navigation and other matters.



A cruise ship navigates Tamatea/Dusky Sound. Photo: Rebecca McLeod

Radio communications

Although there have been recent improvements in VHF (very high frequency) radio facilities and therefore coverage throughout Fiordland, it's important to know that due to the geography of this vast area, there are still corners of the fiords where VHF reception can be fickle.

To maximise the chance of receiving and transmitting clear VHF radio reception, it is therefore recommended that VHF radios be fitted with a good quality aerial.

Vessels with poor aerials may be unable to 'trigger' many of the repeaters, limiting a vessel's communications, so it is recommended you have either a single side band (SSB) radio, or satellite internet technology, in addition to a VHF radio.

There is still no radio coverage throughout every remote corner of Fiordland, so radio contact cannot always be assured. Today, many regular visitors to Fiordland invest in a satellite phone or satellite internet technology (eg, Starlink) to ensure reliable communication, which generally works well except in the tightest, steepest of anchorages/arms.



There is no cell phone coverage in any part of coastal Fiordland, and only very limited range in Piopiotahi/Milford Sound village.

It's important to understand that due to terrain, weather and the remote aspect of much of Fiordland, help is not always available. There are times during bad weather when helicopters are unable to fly into the fiords because of strong winds or low cloud cover, and landing sites are few.

General ship-to-ship communication

Commercial vessels (and small aircraft) in the southern Fiordland–Foveaux Strait–Rakiura/Stewart Island area generally monitor VHF Channel 10, which is used as a working channel for ship-to-ship communications. These channels are only monitored by other vessels in range and are not monitored by any land-based stations.

The Fiordland coastline can be divided into three distinct regions for the purposes of VHF 'ship-to-ship' working frequencies.

The most used working channels for the Fiordland area are:

- Channel 67 – Te Hokiiauau/Big Bay to Hāwea/Bligh Sound
- Channel 74 – Hāwea/Bligh Sound to Hinenui/Nancy Sound
- Channel 10 – Hinenui/Nancy Sound to Bluff.

VHF radio repeaters

Channel 64 – The repeater on Rugged Mountain near Papa Ponamu/Poison Bay provides coverage between Jackson’s Bay and Te Houhou/George Sound.

Channel 66 – This high-altitude repeater is located at 1,855 metres on Mt Irene at the head of Taiporoporo/Charles Sound. The repeater is the most widely used in Fiordland and has the best inner fiord coverage from Patea/Doubtful Sound to Hāwea/Bligh Sound, with operators able to access the channel between Piopiotahi/Milford Sound and Te Puaitaha/Breaksea Sound. Coastal coverage is available offshore from West Cape to offshore Big Bay; however, the best coverage is from Patea/Doubtful Sound to Papapounamu/Poison Bay.

Channel 01 – A repeater has been installed at Wednesday Peak to improve the coverage in the Puysegur area. This provides good coverage throughout Taiari/Chalky Inlet and Rakituma/Preservation Inlet. Coverage can also be obtained at the outer reaches of Te Puaitaha/Breaksea Sound, the Acheron Passage, and parts of Tamatea/Dusky Sound.

Channel 61 – Located on Bluff Hill. Coastal coverage extends from Bluff to Puysegur Point. Within the outer reaches of Taiari/Chalky Inlet and Rakituma/Preservation Inlet coverage is patchy.

Channel 65 – Located on Rakiura/Stewart Island. Coastal coverage extends around the south coast from about 3 nautical miles north of Cape Providence to 3 nautical miles north of the Nuggets, and is patchy in Taiari/Chalky Inlet and Rakituma/Preservation Inlet.

Channels 61 or 65 may be used for calling in the Foveaux Strait area.

Maritime radio

VHF coastal coverage is provided by Maritime Radio from stations at Wednesday Peak in Rakituma/Preservation Inlet (Puysegur Maritime) and Mount Elder in Te Houhou/George Sound

(Fiordland Maritime) and is operated remotely from Lower Hutt. Maritime Radio routinely broadcasts the current maritime weather forecasts. Bluff Maritime Radio also provides coverage in the Foveaux Strait area.

All calls should be made on Channel 16 (monitored), moving to a specified working channel as instructed by the operator.

Fiordland Maritime Radio

Channels 16, 71 (Mount Elder, Te Houhou/George Sound)

For Channel 71 – Coverage is good in the coastal area between Te Hokiua/Big Bay and Taitetimu/Caswell Sound; however, south of Taitetimu/Caswell Sound to Te Rā/Dagg Sound vessels will need to be more than 1 nautical mile offshore to obtain coverage. Inner fiord coverage is restricted to Hāwea/Bligh Sound and Te Houhou/George Sound, although patchy coverage can be received in areas from Patea/Doubtful Sound north. There are weather broadcasts on this channel at 01:33, 05:33, 07:33, 10:33, 13:33, 17:33 and 21:33.

Puysegur Maritime Radio

Channels 16, 67 (Wednesday Peak, Preservation)

For Channel 67 – Coverage offshore is good. Coverage extends over most of Rakituma/Preservation Inlet and a lot of Taiari/Chalky Inlet, but becomes patchy in the upper reaches. Coverage is patchy in Te Puaitaha/Breaksea Sound and Tamatea/Dusky Sound, but can be found mainly in north–south trending waterways where side valleys extend in the direction of Puysegur radio station. There are weather broadcasts on this channel at 01:33, 05:33, 07:33, 10:33, 13:33, 17:33 and 21:33.

Bluff Maritime Radio

Channels 16, 68 (Foveaux Strait)

For Channel 68 – Coverage is for the Foveaux Strait area and does not include parts of Fiordland.

VHF repeaters in Fiordland and surrounds

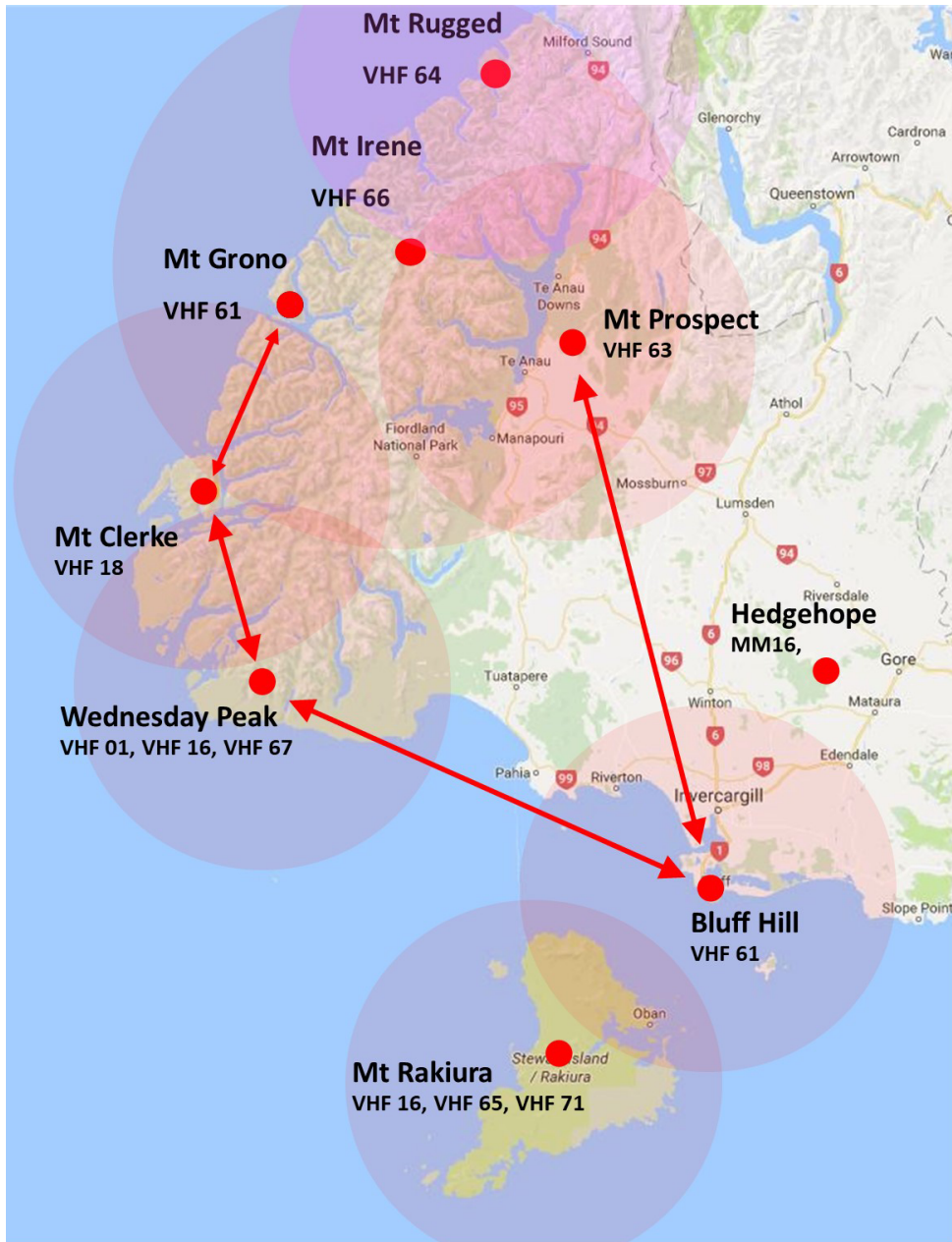

● Existing repeater site ↔ Linking between sites

Radio operators in the area

Fiordland Fishermen's Radio and Bluff Fishermen's Radio provide SSB and VHF coverage throughout Fiordland. Fiordland Lobster Company is a contact point for berthage in Deepwater Basin, Piopiotahi/Milford Sound, while Rakiura/Stewart Island Fisherman's Radio provides coverage throughout Foveaux Strait (as well as Rakiura/Stewart Island).

Piopiotahi/Milford Sound: Fiordland Lobster Company

Based in Deepwater Basin.

Phone: (03) 249 8093

Operator: Rob Smith

Visitor berths and diesel fuel available.

VHF channel / SSB KHZ	Monitored hours NZ local time	Weather broadcasts
67	Open during working hours	

Fiordland Fishermen's Radio

Based in Te Anau.

Phone: (03) 249 7402

Repeater: Mt Irene Channel 66

Operator: Carol Brown

VHF channel / SSB KHZ	Monitored hours NZ local time	Weather broadcasts
66 Mt Irene	Open 24 hours. Skeds at 08:00–08:30 + 19:00–19:30	08:00 + 19:00 (local weather)
2444 vessel receives	Open 24 hours. Skeds at 08:00–08:30 + 19:00–19:30	08:00 + 19:00 (local weather)
2480 vessel transmits	Open 24 hours. Skeds at 08:00–08:30 + 19:00–19:30	08:00 + 19:00 (local weather)
4417	19:30 Listens	

Bluff Fishermen's Radio

Based in Bluff.

Phone: (03) 212 7281/(03) 212 7369

Repeaters: Bluff Hill Channel 61 and Mt Prospect Channel 63 (linked), Wednesday Peak Channel 01, Mt Rakeahua Channel 65

Operator: Meri Leask, "Good as Gold"

VHF channel / SSB KHZ	Monitored hours NZ local time	Weather broadcasts
16	Open 24 hours	
61 Bluff (linked to 63 Mt Prospect)	Open 24 hours	07:05 + 17:30 (and on request)
65 Mt Rakeahua	Open 24 hours	07:10 (and on request)
66 Mt Irene	Open 24 hours	
01 Wednesday Peak	Open 24 hours	07:30 + 17:35 (and on request)
4417	Opens at 07:15	07:15 + 20:30 (and on request)

Rakiura/Stewart Island Fishermen's Radio

Based in Halfmoon Bay.

Repeaters: Mt Rakeahua Channel 65, Bluff Hill Channel 61, and Mt Prospect 63 (linked)

Call: ZLRZ Halfmoon

VHF channel / SSB KHZ	Monitored hours NZ local time	Weather broadcasts
16	Open 24 hours	
65 Mt Rakeahua	Open 24 hours	09:25 + 17:25
61 Bluff (linked to 63 Mt Prospect)	Open 24 hours	09:28
4417	Open 24 hours	09:31 + 17:28
10	Listens	

For further information refer to the **Radio Handbook**, produced by Maritime New Zealand.

Fisheries information and guidelines



Managing Fiordland's fisheries

Every year, growing numbers of visitors come to Fiordland to experience the unique fishing and diving opportunities available. While it's great to see more people enjoying this incredible place, this places pressure on Fiordland's vulnerable fisheries. It's important the environment and fisheries are maintained or improved for future generations to use and enjoy. This section provides information about key target species and outlines the special recreational fishing rules that apply to the Fiordland Marine Area.

The difference between the inner and outer fiords

While the marine area of Fiordland appears vast, not all areas of the fiords can sustain the same level of fishing pressure. For example, the outer reaches of the fiords and the open coast can support a higher level of fishing pressure than the inner fiords, as it's here on the outer coast that the marine environment is more productive.

The marine environment in the inner fiords is relatively dark due to the tannin-stained freshwater filtering sunlight out, but also often from the shade from the steep surrounding mountains. These low light conditions reduce the growth of the seaweeds and phytoplankton that typically fuel marine life. As a result, fish life here is typically less abundant, slower growing and low breeding.

The recruitment of new individuals into the inner fiords can be further challenged by larvae not being able to tolerate the low salinity of surface waters. The relatively sheltered waters of the inner fiords are easier to access than the more wave-exposed outer fiords and open coast, which can also translate to higher fishing pressure. Because of these factors, fishing harvest inside the fiords must be carefully managed.

In stark contrast, the outer fiords and open coast are environments with plenty of light, lots of wave energy, and nutrient-rich waters. In these areas, faster growth and higher rates of reproduction of key species means that fisheries are able to support a higher level of fishing effort.

Fisheries management – An ongoing challenge

This difference between inner and outer fiords was critical to the decisions in 2005 around fisheries management in the Fiordland (Te Moana o Atawhenua) Marine Area. Commercial fishers agreed to withdraw from the Internal Waters, and these areas became official commercial exclusion zones. Amateur fishing limits were reduced at the same time, and tiered limits were brought in for blue cod and proper to discourage fishing in the Internal Waters.

At the time, most of these fishing rules were regarded as highly conservative compared to other parts of the country. Unfortunately, however, due to a significant increase in the number of recreational vessels visiting Fiordland, staying longer, and going further, these fishing limits have not been enough to sustain or manage a healthy fishery.

The sustainable management of popular recreational fish and shellfish species has been a challenge that the Guardians have grappled with for decades. As the number of visitors to Fiordland grows, the places people are spending time in changes, and the ocean conditions evolve due to climate change, the management settings continue to get reviewed.

2024 – New fishing rules

Unfortunately, despite Fiordland’s conservative fishing limits, by 2019 it became apparent that management measures were not working. At this time the Guardians began fielding concerns from regular visitors to the area, and the Guardians were also experiencing poor fishing first-hand.

They consulted widely with the fishing community and concluded that there was serial depletion of key stocks including blue cod, groper, scallops and pāua from throughout many parts of Fiordland – but this time, depletion wasn’t confined to the inner fiords. There were clear signs that the entrances to many fiords – popular with recreational fishers due to the higher blue cod and groper daily limits and shelter from the ocean swells – had also been depleted of target species. The Guardians heard that it had become difficult to catch any finfish, even in the southern fiords where the fishing has historically been ‘good’.

The sustainability of all of Fiordland’s fisheries – including all finfish, lobster and shellfish species – was then reviewed. Extensive community engagement and analysis resulted in the Guardians making several recommendations to the Minister for Oceans and Fisheries, and a series of new fishery regulations, some far more conservative, have since come into effect.

As part of the 2024 amateur fishing rules, a new defined fishing area called ‘the Fiords’, has been created, encompassing all waters lying inside the outer headlands at the entrance of each fiord. See ‘**Defining the area**’, page 50.

These fishing rules are designed to encourage people to fish in the most productive areas, while also protecting the most accessible productive areas – the fiord entrances – from concentrated fishing effort.

The Guardians have made these rather drastic changes in the hope that it will lower fishing pressure in the Fiords to a level where the fishery can not only be sustained, but actually rebuild to healthy levels. They have a long-term focus, in line with their vision, which is all about maintaining or improving fisheries for future generations.



Please help by following the rules, reporting your catch, and treading lightly in this special place.

‘Fish for a feed’

The Guardians promote the ‘fish for a feed’ philosophy of recreational fishing. They do not consider that Fiordland is the right place to come to if you want to fill your freezer.

Some of the ways you can fish for a feed are:

- fish mindfully – take only what you need for a fresh meal for yourself and your family
- avoid fishing in the inner fiords
- move your boat often while fishing to spread your effort
- only set fishing gear if you are confident you will be able to retrieve it in good time
- know how to catch, handle and return fish, shellfish and rock lobster with care
- understand and stick to the fishing rules.

See also ‘**Guidelines for handling finfish**’, page 58; ‘**Blue cod (rāwaru)**’, page 59; ‘**Pāua**’, page 66; and ‘**Rock lobster (crayfish)**’, page 68.

Recreational fishing information and rules

It is critical that all fishers know, understand and obey the fishing rules that apply in the Fiordland (Te Moana o Atawhenua) Marine Area. By taking responsibility for your actions and complying with the law you can help conserve and replenish our valuable fisheries for future generations to use and enjoy.

The following notes are provided as a summary guide of applicable law, which is subject to change. Relevant legislation includes the Fisheries Act 1996, Fiordland (Te Moana o Atawhenua) Marine Management Act 2005, and the Fisheries (Amateur Fishing) Regulations 2013.

The information contained in this guide is correct at the time of printing and is subject to change without notice.



It is your responsibility to make sure you have the most up-to-date rules during your time in Fiordland.

Please contact your nearest Ministry for Primary Industries Fisheries New Zealand office or visit www.fisheries.govt.nz/rules to check the rules that apply. Download the free **NZ Fishing Rules** app from your app store or by texting 'app' to 9889.

Know and observe the limits

The main points to remember are:

- do not take more than the daily limit entitlement*
- all fish taken and consumed during any trip must be counted within the daily limit entitlement*
- do not take undersized fish
- ensure all baitfish are legal size
- unlawful catch in excess of daily limit, or undersized or illegal, must be immediately returned to the water, dead or alive
- it is illegal to sell or trade your amateur fish catch
- breaking the fishing rules can result in hefty infringements, court fines, and property forfeiture.

*Note: Only people actively taking finfish, rock lobster or shellfish are entitled to claim a catch within the daily limit.

Fishers should also be aware of the closed seasons, closed areas, and fishing gear and method prohibitions that apply within the Fiordland Marine Area and the wider Southland Fishery Management Area.

Defining the area

The Fiordland Marine Area encompasses the Fiordland coastal marine area waters, beginning from Awarua Point on the West Coast of the South Island and extending 12 nautical miles seaward from the mean high-water springs mark, along the Fiordland coast to its south-eastern boundary point at Sand Hill Point in Te Waewae Bay.

The Fiordland Marine Area management zones includes the following defined waters:

- the Fiords
- the Internal Waters of Fiordland (Internal Waters)
- the Milford Sound (Piopiotahi) blue cod closure area.

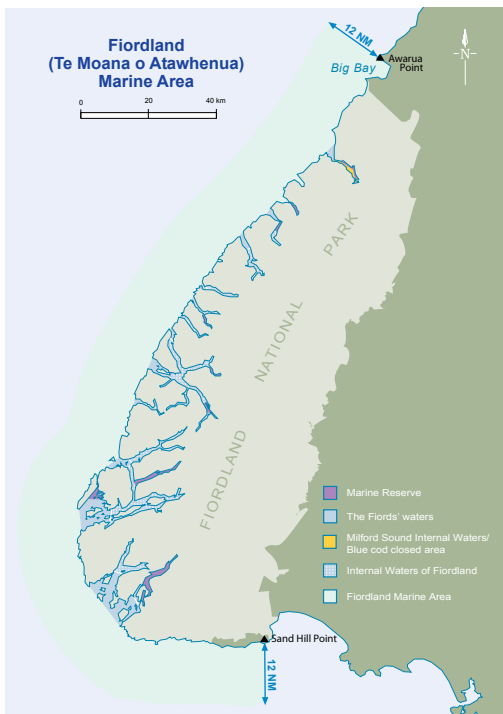

Fiordland Marine Area management zones.

These defined areas are not marked with physical markers. To avoid any accidental fishing breaches, fishers and vessel skippers are encouraged to familiarise themselves with the boundary coordinates and topography features provided in maps located in the ‘**Fiord-by-fiord guide**’ section and to ensure they always remain spatially aware.

The Fiords

The Fiords encompass all of the waters lying east of a defined fiord entrance line extending across and between the respective fiord entrance outer headlands of 14 named fiords. The Fiords include the existing Internal Waters within each fiord. The exact coordinates of each fiord entrance line are provided in the ‘**Fiord-by-fiord guide**’ section. The point coordinates for each of the fiords’ entrance lines are defined in Schedule 18 of the Fisheries (Amateur Fishing) Regulations 2013.

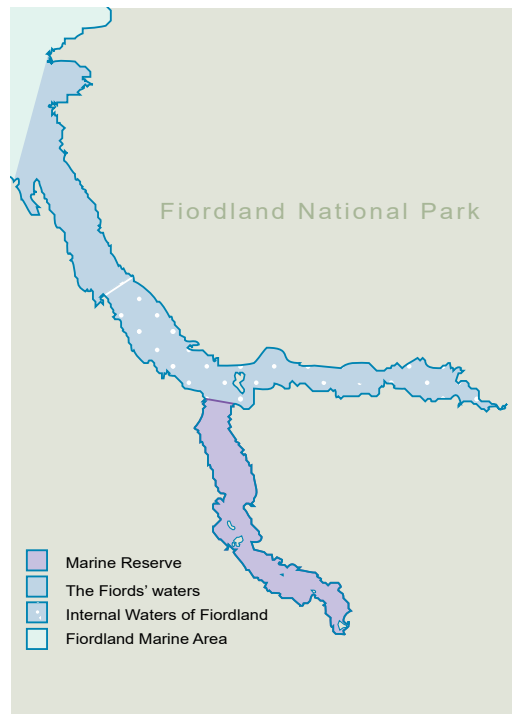

Close-up of Taiporoporo/Charles Sound showing various management zones.

Internal Waters of Fiordland

The Internal Waters are defined inner fiord areas within the Fiords and are demarcated by what are known by most as habitat lines in each fiord. The boundary coordinates of the habitat lines, and the Internal Waters of each fiord are shown on the maps in the ‘**Fiord-by-fiord guide**’ section.

All commercial fishing is prohibited in the Internal Waters, creating a 46,000-hectare non-commercial fishing area. Conservative recreational fishing restrictions apply to the Internal Waters for reasons explained at the beginning of this section.

Areas with additional fishing restrictions

Some areas within the Fiordland Marine Area have special restrictions such as total protection prohibiting all fishing, species prohibitions, and fishing method restrictions.

Marine reserves

Fish and marine life in the marine reserves are completely protected with all fishing, both non-commercial and commercial, totally prohibited.

See ‘**Marine Protected Areas**’, page 28 for more information on marine reserves in the Fiordland Marine Area. Details of each marine reserve including maps are provided in the ‘**Fiord-by-fiord guide**’ section.

The Milford Sound (Piopiotahi) blue cod closure area

It is prohibited to take or possess blue cod from within the Internal Waters of Piopiotahi/Milford Sound. This area closure is due to natural low blue cod abundance and the high accessibility of this fiord to recreational fishers making the species susceptible to localised depletion.

Internal Waters – groper (hāpuku/bass) fishing closure

It is prohibited to possess or take groper from the Internal Waters of every fiord within the Fiordland Marine Area. The zero limit for groper in the Internal Waters is due to concerns about declining abundance of this species and susceptibility to fishing pressure. See note on **groper (hāpuku/bass)**, page 61.

The Fiordland Marine Area – scallop and oyster closure

It is prohibited to take scallops and flat/dredge oysters from the entire Fiordland Marine Area due to the decline in abundance of these shellfish species from the few places where they once could be found. While these species have never been highly abundant in Fiordland, disease diebacks, variable recruitment, and localised depletion by regular and sustained harvest pressure have likely all contributed to their decline.

Pendolo Reach, Patea/Doubtful Sound – prohibited rock lobster pot area

It is prohibited to use or set any rock lobster pot or rock lobster holding pot in the Pendolo Reach area of Patea/Doubtful Sound. The area is adjacent to Seymour Island.

The potting prohibition was introduced in 2013 following the discovery of rare and fragile seabed species on this bottom sill. The Guardians identified the anchoring of large cruise ships and seafloor damage from heavy fishing gear as potential risks.

More information about this china shop can be found on **page 111**.

Waitutu Mātaitai Reserve – pāua prohibition

This Mātaitai Reserve on the south coast of Fiordland has the following fishing bylaws:

- all commercial fishing is totally prohibited within the Mātaitai Reserve
- all recreational pāua fishing (black-foot and yellow-foot) is prohibited within the Mātaitai Reserve.

See ‘**Mātaitai**’, page 30 for further information.

Finfish

New amateur fishing rules were introduced for the Fiordland (Te Moana o Atawhenua) Marine Area in 2024. Further changes are possible, so please visit the Fisheries New Zealand website (www.fisheries.govt.nz/rules) or get the **NZ Fishing Rules** app for the most up-to-date information.

Combined species bag limits and individual species daily limits can vary in different parts of the Fiordland Marine Area. Refer to ‘**Defining the area**’.

Combined finfish daily bag limit

The combined finfish daily bag limit applies to all finfish species, including any fish species not listed in table 2.

There is a **combined daily bag limit of 20 finfish** per active fisher with no accumulation applying. The combined maximum daily bag limit of 20 finfish includes all finfish caught outside the Fiords and any finfish caught inside the Fiords and the Internal Waters.

When fishing exclusively inside the Fiords, including the Internal Waters, there is a **combined daily bag limit of 10 finfish** per active fisher with no accumulation applying. Any fish taken from the Fiords must be included and counted together with any finfish taken outside the Fiords to comply with the Fiordland Marine Area combined bag limit of 20 finfish per person.



Individual species limits within the combined daily bag limit must not be exceeded.

Individual species limits

Individual species limits are listed in table 2. Note that for several species there are lower limits within the Fiords. The species limit for the Fiordland Marine Area includes all fish caught outside the Fiords and any fish caught inside the Fiords and the Internal Waters of Fiordland. When fishing exclusively inside the Fiords, any fish taken from the Fiords must be included and counted together with any fish taken outside the Fiords to comply with the individual species limit.



Accumulation of finfish beyond the daily limit is prohibited.

Accumulation

‘Accumulation’ refers to the aggregation and possession of daily fish catch of more than one day’s legal entitlement for any person, which is unlawful for finfish and shellfish taken from the Fiordland Marine Area. In respect to Fiordland, accumulation doesn’t just apply to fish in your possession on a boat or on landing ashore, but also applies to possession of catch in any vehicle, including an aircraft, and for any fish that is stored on your property (eg, your home freezer). For rock lobster, there is a three-day maximum accumulation limit of 15 rock lobsters, with special provisions applying. See ‘**Rock lobster (crayfish)**’, page 68.

South West blue cod management area

In July 2020 a blue cod traffic light system was introduced to sustainably manage the South Island's blue cod fish stocks. There are nine blue cod management areas in the framework.

Under the traffic light system, the daily limit is set based on the stock health abundance and can be changed as fish stocks improve or decline. In red areas, stocks are in trouble; in orange areas stocks are either rebuilding or declining; and in green areas stocks are considered healthy.

The South West blue cod management includes all New Zealand fisheries waters bounded between Sand Hill Point, Te Waewae Bay and the Haast River mouth, South Westland and extends 12 nautical miles seaward from the mean high-water mark to the outer limit of the New Zealand Territorial Sea. The Fiordland Marine Area lies within the South West blue cod management area, with no accumulation beyond one day's limit of 10 and a lower daily limit of 1 blue cod applying within the Fiords' waters. Different daily limit, accumulation and measurable state rules apply to the neighbouring Southern blue cod management area waters, lying east of Sand Hill Point and the Westland area waters lying north of the Haast River mouth.

Lowest blue cod daily limit applies

When transiting from one blue cod management area to another, for example from the Southern area to the South West area, or transiting from outside the 12 nautical mile Territorial Sea, fishers must observe and not exceed the lowest blue cod daily possession limit and applicable accumulation limit.

Within the Fiordland Marine Area fishers can lawfully possess the legal South West area blue cod limit of up to 10 blue cod, taken from outside the Fiords' waters, to transit inside and through the Fiords' waters and Internal Waters, where the lower take and possession limit applies. This also includes the Piopiotahi/Milford Sound blue cod closure area.

Unlawfully taken fish (dead and alive)

Unlawfully taken fish (such as fish taken in excess of daily limit, undersized, unlawful state, or fish taken with prohibited gear or method) must be immediately returned to the water, taking all care to ensure the fish is unharmed and returned to the same location from where it was taken. You must also return dead unlawful fish to the water.

Table 2: Individual species limits for finfish in the Fiordland Marine Area

Finfish species	Fiordland Marine Area (outside the Fiords) Maximum daily limit per active fisher within 20 finfish bag limit	The Fiords' waters Maximum daily limit per active fisher within 10 finfish bag limit	Minimum fish length (cm)
Albacore tuna	10	3	–
Barracouta	20	3	–
Blue cod – excluding Milford Sound (Piopiotahi) blue cod closure area [^]	10	1	33
Blue cod – Milford Sound (Piopiotahi) blue cod closure area	No take allowed		
Blue moki	5	1	40
Bluenose	3	1	–
Blue shark	1		–
Bronze whaler shark	1		–
Butterfish (Greenbone)	4	2	35
Elephant fish	5		–
Flatfish (except sand flounder)	5	2	25
Groper (hāpuku/bass) – excluding Internal Waters closed to taking groper (hāpuku/bass) [#]	3	1	–
Groper (hāpuku/bass) – Internal Waters closed to taking groper (hāpuku/bass)	No take allowed		

Finfish species	Fiordland Marine Area (outside the Fiords) Maximum daily limit per active fisher within 20 finfish bag limit	The Fiords' waters Maximum daily limit per active fisher within 10 finfish bag limit	Minimum fish length (cm)
Hammerhead shark	1		–
Hoki	5	1	–
Kahawai	5	1	–
Kingfish	3		75
Ling	5	1	–
Mako shark	1		–
Marblefish	5	1	–
Marlin	1		–
Porbeagle shark	1		–
Red cod	5	2	25
Red gurnard	5	2	25
Red moki	5		40
Rig	2		–
Sand flounder	5	2	23
School shark	2		–
Sea perch (Jock Stewart)	10	1	–
Seven-gilled shark	1		–
Skate/Ray	1		–
Snapper	5		25

Finfish species	Fiordland Marine Area (outside the Fiords) Maximum daily limit per active fisher within 20 finfish bag limit	The Fiords' waters Maximum daily limit per active fisher within 10 finfish bag limit	Minimum fish length (cm)
Southern bluefin tuna	1		–
Spiny dogfish	2		–
Stargazer	5	2	–
Tarakihi	10	1	25
Thresher shark	1		–
Trevally	5	1	25
Trumpeter	5	1	35
Warehou	5	1	–
Wrasse	10	4	–
Any other finfish* for which a specific limit is not specified in this table	10	4	

^ It is prohibited to take or possess blue cod taken from within the Internal Waters of Milford Sound (Piopiotahi) blue cod closure area.

It is prohibited to take or possess groper from the Internal Waters of every fiord in the Fiordland Marine Area.

* Whether of the same or different species. Finfish includes all species of finfish of the classes Agnatha, Chondrichthyes and Osteichthyes, at any stage of their life history, whether living or dead. Excluding eels and baitfish.



IMPORTANT NOTES

For the avoidance of doubt, the respective daily limits for finfish species taken within the Fiords must be counted and included as part of the respective maximum species daily limits and combined finfish bag limit for the Fiordland Marine Area and are not additional.

It is unlawful to take or possess any white pointer shark, which is a fully protected species.

Baitfish daily limits

In addition to daily finfish bag limits, you may take the baitfish species as outlined in table 3.

Table 3: Individual limits for baitfish in the Fiordland Marine Area

Finfish species	Maximum daily limit per active fisher
Anchovy	Daily limit of 50 for any combination of these species
Jack/Horse/Chilean mackerel	
Koheru/Scad	
Pilchard	
Piper/Garfish	
Slender/Stout sprat	
Yellow-eyed mullet	

Measuring finfish

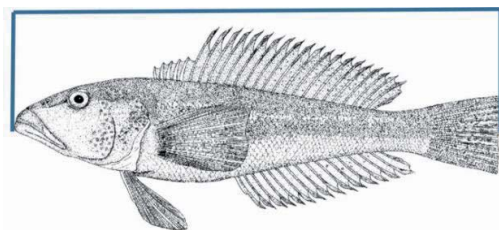

Measure finfish length from the tip of the nose to the rear end of the middle ray or 'V' of the tail fin, as shown.

Please note the rules regarding measurable state for blue cod in the '**Blue cod measurable state**' section, page 61.

Method and gear restrictions

Set nets and drift nets prohibited

It is unlawful to recreationally use, set or possess any set net in the Fiordland Marine Area. It is also prohibited to use a drift net for fishing in any New Zealand fisheries waters.

Setline restrictions

Setline restrictions apply to all static line gear that is set in the water and not attached to a vessel in New Zealand fisheries waters. This includes longlines and dahn (drop) lines but does not include any rod and reel line or handline.

Within the Fiordland Marine Area, including the Fiords and Internal Waters, the following setline fishing restrictions apply:

- Surface floats attached to any setline must be legibly and permanently marked with the fisher's surname and initials; the boat name is also useful.
- A maximum of 5 hooks per setline is allowed.
- If only one person is on a vessel, a maximum of 1 setline may be used or set.
- If two or more persons are on a vessel, no more than 2 setlines may be used or set from, or possessed, on board that vessel.

Guidelines for handling finfish

We all need to protect the small fish because they are the future breeding stock. If we reduce the number of breeding fish, there will be fewer fish to replace those that are caught, and this would mean a decline in the stocks of our most popular finfish species.

To catch the best fish possible, but also to ensure undersized fish survive, please:

- remove fish from the water only if you have to and minimise the time fish are out of the water
- wear gloves, or wet your hands before handling fish
- lie fish on a soft wet surface if you need to handle them out of water
- change to a larger hook size if you are catching a lot of small undersized fish
- remove the hook carefully from a lip-hooked fish
- cut the line for a gut-hooked fish.

Do not:

- hold fish by inserting your fingers inside the gill covers
- poke or touch the eyes, and never hold fish by the eye sockets
- use a 'gob' stick device to remove a fish hook from inside the gullet of a fish you will release
- squeeze hard on the gill covers or gut area
- lift fish by the tail, as this can dislocate the spine
- drop or place fish on a hot, dry deck or on to rocks.

Lines

- Use only enough line to reach the bottom – this keeps tension on the line, so you'll know when you've caught a fish.
- Use only one hook per line when rod and hand lining.
- Once you've 'hooked' a fish, check and retrieve the line immediately.

Hooks

Hook type is important. Blue cod and hāpuku/groper 'bite' the hook when taking the bait and then 'twist'. If hooks are swallowed, they are likely to damage the throat or gills, which almost certainly results in death. Larger wide gap and circle hooks tend to hook the fish in the front of the mouth, making them easier to unhook.

Large hooks also reduce the amount of undersized fish caught. This is particularly important for hāpuku/groper as they have a gas-filled swim bladder. Bringing these fish to the surface on a line commonly causes damage to the swim bladder, which results in the death of the fish.



Large hooks (size 8 and larger) are strongly recommended and, even better, use barbless hooks to reduce damage to undersized fish.

Only use one hook per rod or hand line, as the use of multi-hook rigs will lead to fish being poorly handled, reducing the chance of undersized fish surviving when released.

Returning undersized finfish

When returning undersized fish, handling time should be kept to a minimum, **as they cannot survive more than a couple of minutes out of the water.** When releasing fish, try to avoid predators such as mollymawks (Buller's albatrosses) and barracouta. PVC downpipe escape tubes for the fish to slide down into the water can be a useful method, but it is important to avoid serial returns of small fish that encourage the build-up of predators both above and below the surface. If you find yourself returning lots of undersized fish in one spot, move on to somewhere else.

Blue cod (rāwaru)

Blue cod – *Parapercis colias* or rāwaru – is one of the most sought after and valued recreational fish species in the Fiordland Marine Area. Despite good fishing on the outer coast, blue cod are scarce, and becoming increasingly so, in the more sheltered waters of the narrow, steep-walled fiords.



Blue cod (rāwaru). Photo: Steve Wing

Blue cod traits

Blue cod are typically more abundant on the outer coast and fiord entrance areas, but populations are much lower in the middle and inner reaches of the fiords. These differences are driven by the availability of food and good habitat, which ultimately affect the reproductive rates and ability for blue cod populations to be replenished with young fish.

There is also a contrast between the northern fiords and southern Fiordland. In the north, some steep-walled fiord habitats with narrow entrances have low food availability, which naturally inhibits blue cod numbers. In contrast, in the southern fiords there is more rough ground habitat for blue cod to inhabit, and wave energy and light moves into the fiords, creating better conditions for blue cod growth and reproduction.

Blue cod are highly territorial, which means they tend to stay in one area – generally moving only within a 1 kilometre home range. It's therefore very easy for fishers to deplete that area, particularly in the inner fiords. That presents a further problem – if the number of dominant large males present in a local population is low, females can change sex. A population that has an unbalanced number of males and females is not as effective at breeding and replenishing the fishery.

Blue cod take several years to reach maturity. In Southland, male blue cod can take 7–9 years to reach the minimum legal-size length of 33 cm. They can live for up to 32 years, reach a length of 60 cm, and weigh up to 4 kg. Which is why it's essential to endeavour to only catch larger legal-sized fish and to ensure the survival and swift return of undersized blue cod.

An ever-changing fishery

The sustainability of the blue cod fishery was a major concern when the Guardians began their work in the 1990s, and became a key consideration in developing the Guardians' marine conservation strategy.

In 2005, new amateur fishing rules and regulations were introduced for blue cod in Fiordland. These included reduced daily limits and no daily accumulation rules. At the same time, Piopiotahi/Milford Sound and Patea/Doubtful Sound were closed to all amateur blue cod fishing to assess stocks, and to allow and measure recovery of the population without fishing pressure. Monitoring of the stocks included potting surveys for abundance, size and sex distribution, tag and release to assess movement of fish, and comparison of the closure areas with stocks in the marine reserves.

The monitoring found that regardless of the fishery closures, blue cod numbers in both inner fiords remained low. This is thought to be due to low rates of reproduction (survival of larvae through to young fish) and low levels of fish moving into the areas from the mid- and outer-fiords. In Piopiotahi/Milford Sound, it is considered by the Guardians to be unlikely that blue cod stocks will ever be able to sustain moderate recreational fishing pressure over the long term due to their low natural abundance.

In 2015, at the Guardians' request, Patea/Doubtful Sound was reopened with a daily limit of one blue cod per person, and this limit applied across the combined Internal Waters of Te Awa-o-Tū/Thompson Sound and Kaikiekie/Bradshaw Sound. This move was to spread harvest effort across this larger area.

Unfortunately, all these attempts to sustainably manage the blue cod fishery have not stood up to the ever-increasing number of recreational fishers visiting the area.

New rules and regulations were introduced in the Fiordland Marine Area in 2024, including drastic reductions to the bag limits for blue cod in the Fiords. The Guardians consider that in many parts of Fiordland blue cod stocks don't just need protecting, but actually require rebuilding. The goal is that in the future, blue cod will become plentiful again for people to enjoy.

The Guardians are now supporting the development of new monitoring methods for blue cod and other finfish species so the effect of the new rules can be measured. The new methods use baited underwater video to attract, record and measure fish over a set period. Compared to traditional potting survey methods, baited underwater video is cost effective and low impact.

Commercial fishing for finfish (predominantly blue cod and hāpuku/groper) is largely historic in Fiordland, beginning at the turn of the 20th century when a fish freezer was established in North Port, Taiari/Chalky Inlet. The fishery waxed and waned for the following few decades, never quite being profitable enough to sustain the industry. Similarly, today, any commercial blue cod fishing is limited by price and fuel costs. Therefore, most of the commercial blue cod catch is taken from more accessible fishing grounds in the wider BCO5 management area than Fiordland offers, for example around Rakiura/Stewart Island and Foveaux Strait.

Blue cod fishing rules

Make sure you know the fisheries regulations. Maximum daily limits for recreational blue cod fishing are outlined in the '**Finfish**' section, page 52.

The other main fisheries rules are:

- the blue cod minimum legal length is 33 cm
- measure and immediately return undersize blue cod to the water
- all blue cod catch possessed in New Zealand fisheries waters on a vessel must be retained and landed in a whole, or gutted measurable state (minimum length 33 cm)
- **blue cod fishing is prohibited in the Internal Waters of Piopiotahi/Milford Sound**, which is closed to blue cod fishing because of scarcity and to promote sustainability
- all fishing or **taking of fish is strictly prohibited in any of the marine reserves**. See '**Marine Protected Areas**', page 28
- using and retaining undersized blue cod (less than 33 cm in length) for bait is illegal – they must be immediately returned to the water, alive or dead
- do not 'high-grade' blue cod, that is, do not discard previously caught dead fish of legal size back into the sea if bigger fish are caught.

Blue cod measurable state

Measure and return undersize blue cod immediately to the water. In New Zealand fisheries waters all blue cod catch possessed on a vessel must be retained and landed in a whole, or gutted measurable state (minimum length 33 cm). For blue cod, 'gutted', means the removal of the abdominal cavity organs. When you 'bleed' blue cod, do not cut out the gills or sever the spine to compromise the measurable state.

While it is unlawful to possess or land processed blue cod in an unmeasurable state, fishers on board a fishing vessel may possess blue cod in a processed state if it is to be **immediately** eaten on board the fishing vessel from which it was taken. Any fish eaten, form part of the daily limit. If you have filleted blue cod on shore to take home, you cannot take the fillets back on a vessel in New Zealand fisheries waters to transport in an unmeasurable state.

Blue cod pots

It is **prohibited to use or set any blue cod pot in the Internal Waters of Fiordland**. They can, however, be used outside the fiord Internal Waters in accordance with the following pot limit rules:

- All pots, and surface buoys or floats attached to the pot and float line, must be legibly and permanently marked with the person's initials and surname. This includes possession on any vessel.
- Blue cod pots must use a single layer of rigid square mesh with minimum inside width dimensions of 54 mm for undersize fish escapement.
- Pot limits apply to all catching pots including blue cod pots and rock lobster pots with pot possession and use restricted to:
 - ▶ a maximum of 3 pots for one person, or
 - ▶ if two or more persons are on a vessel, the maximum vessel pot limit is 6 pots, being any lawful combination of species-specific catching pots and including no more than 3 rock lobster catching pots and up to 2 rock lobster holding pots.

Groper (hāpuku/bass)

Hāpuku/groper (*Polyprion oxygeneios*) and bass groper (*Polyprion americanus*) are closely related, and their distributions overlap. They are typically treated as one-in-the-same for fishing management purposes, and the name groper is used as a collective term for hāpuku and bass.

Despite groper being one of Aotearoa New Zealand's most prized fish, they are one of the least studied and understood. While there is some general knowledge of their life history and migration to be gleaned from scientific studies around Aotearoa, local fishers suspect that their behaviour in Fiordland may vary. Widespread concerns about the declining trend of stocks in Fiordland have led to recent rule changes for groper, and a call for better monitoring of abundance.



A recreational fisher with a good-sized hāpuku/groper. Photo: Sam Mossman

Groper traits

Both species of groper inhabit a wide depth range, from surface waters down to at least 400 metres. Historically, they were often observed in shallow waters around Aotearoa, but today they are generally restricted to deeper waters. They are large fish – growing up to 180 cm long and up to 80 kg – although it is more common to encounter fish up to about 25 kg. Groper are slow growing and long lived, making them vulnerable to over-fishing. They don't reach maturity until 10–13 years of age, and have been known to live up to 60 years.

Juveniles are generally pelagic and when they mature they become demersal/bottom dwellers. Mature fish spawn in aggregations. In other parts of Aotearoa they spawn in spring and summer, but the time of spawning hasn't been studied in Fiordland. It is widely accepted that mature fish move in and out of the fiords to offshore locations according to their reproductive cycle.

Groper are voracious predators and have a wide-ranging diet including fish, invertebrates (including rock lobster), and even seabirds.

The groper fishery

In Fiordland, groper are an important customary, commercial and recreational species. Groper were once seasonally common close inshore and were prized kai moana for Māori. Recreational fishers have long enjoyed fishing for groper throughout Fiordland. Resident groper tend to be found in the fiord entrance whereas school groper are often associated with freshwater inflows into the fiords including the upper reaches.

A commercial fishery for the species began to be developed in the 1940s, and groper (hāpuku/ bass) are now managed under the Quota Management System. In 2024, the national Total Allowable Commercial Catch (TACC) for groper was 1,491 tonnes, which included a TACC of 451 tonnes for the HPB5 stock, which spans Southland (including Fiordland) and the Subantarctic.

In recent years, the commercial catch of this stock has been significantly lower than the TACC (124 tonnes for year ending September 2023).

When the Guardians of Fiordland's Fisheries assembled in the 1990s, concerns about the decline of stocks were raised by the community. In 2005, the Guardians recommended that daily limits for groper be reduced, and a tiered daily limit was introduced to encourage fishers to focus on more productive fishing grounds.

During the fisheries sustainability review process that began in 2019, the Guardians received strong feedback that it had become increasingly difficult to catch groper in the area, particularly in the inner fiords. The Guardians took a precautionary response to this information and in 2024 the Internal Waters of all fiords were closed to groper fishing. Fishers can target this species in the remaining Fiords' waters (the entrance areas), although they are incentivised by a higher daily limit to fish on the open coast when possible.

The drastic measure to close this fishery was not a move taken lightly. While the Guardians consider the lowest setting – a daily limit of one fish per fisher – was too risky, they are working with Fisheries New Zealand and stakeholders to develop a proposal for a vessel limit to allow a more sustainable level of catch for groper in the Internal Waters.

The Guardians are now supporting the development of new monitoring methods for groper and other finfish species so the effect of the new rules can be measured. The new methods use baited underwater video to attract, record and measure fish over a set period. Groper abundance has never been measured in the fiords, so the introduction of this method will be a big step forward.

Groper (hāpuku/bass) fishing rules

Make sure you know the fisheries regulations. Maximum daily limits for recreational groper fishing are outlined in the **'Finfish'** section, page 52.

The other main fisheries rules are:

- **groper fishing is prohibited in the Internal Waters of Fiordland**, due to concerns about sustainability
- there is no minimum legal length for groper (as catching the fish typically bursts the swim bladder leading to the eventual death of the fish)
- high grading (returning captured fish so that a bigger one can be retained) is illegal
- all fishing or **taking of fish is strictly prohibited in any of the marine reserves**. See **'Marine Protected Areas'**, page 28.

Tuna

While saltwater sportfish have been documented in Fiordland as far back as the 1970s, warmer waters including increasing marine heatwave events seem to be bringing schools of albacore tuna, southern bluefin tuna, yellowtail kingfish, and even swordfish to Fiordland on a more regular basis. Sportfishing out of Piopiotahi/Milford Sound is becoming increasingly popular during mid-summer. These impressive fish are highly migratory, ranging far beyond Fiordland, but we need to respect and care for them while they are here.



Spear-caught southern bluefin tuna, offshore from Piopiotahi/Milford Sound. Photo: Dave Shaw

Tuna traits

When albacore tuna come to Fiordland they tend to do so in large schools. They can live up to 13 years, reaching maturity around 5–7 years of age. They can grow up to 1.2 metres but are more commonly seen ranging from 50–90 cm in length. Albacore spawn in warm waters 15 to 25 degrees south of the equator.

Southern bluefin tuna migrate vast distances between 30 and 50 degrees south. They are long lived – up to 35 years – and don't reach maturity until they are around 1.5 metres long (8 years of age). Southern bluefin breed in the tropics then travel southwards and congregate in coastal areas where the water is warm enough, including sometimes, the coast of Fiordland. They spend the winter months in deeper temperate waters.

Southern bluefin tuna stocks are recovering after being overfished for many years. They have been targeted by surface long-line vessels off the west coast of the South Island since the 1960s and by recreational fishers out of Fiordland since the 1970s.

Aotearoa is a founding member of the Commission for Conservation of Southern Bluefin Tuna, an intergovernmental organisation responsible for their conservation and management. Blue Water Marine Research has set up an online catch reporting form at www.fishcatch.co.nz. Fishers are encouraged to report any Southern bluefin tuna landed or released catch to help complete the picture of this developing fishery.

Fishing rules for tuna

Make sure you know the fisheries regulations. Maximum daily limits for recreational fishing of tuna, kingfish and other highly migratory species are outlined in the '**Finfish**' section, page 52.

The other main fisheries rules are:

- There is a **combined maximum daily bag limit of 20 finfish** per active fisher (excluding specified baitfish species) with no accumulation applying.
- The daily limit for albacore tuna, bluenose, and kahawai is higher in the open waters of the Fiordland Marine Area (outside the Fiords).
- The daily limit for southern bluefin tuna is 1 per active fisher with no accumulation applying.

Guidelines for tuna fishing

Prepare before you go fishing:

- Ensure you have the necessary equipment handy.
- Know the rules and limits, and use an online calculator to figure out how much fish you can keep cool onboard to maintain quality.

When fishing:

- Minimise the 'fight time' to preserve the quality of the flesh. You can do this by using a heavier line class, having a good quality rod and reel that is up to the job, and knowing about better fishing techniques.
- Make sure anything touching the fish is wet, whether this is the net, your gloves, or bare hands. This will protect the skin of the fish from infection, which is particularly important if you plan to release it.
- Use a knotless landing net to support the body weight of the fish.

Boatside:

- If you plan to release the fish, all handling should be done with the fish remaining in the water and water flowing over their gills (boat in gear).
- Here, the fish can either be controlled on the leader or using a pair of lip grips. Using a fixed gaff in the mouth creates another hole the fish must repair.
- If the hook cannot be removed, cut the leader as close to the hook as possible.

Onboard:

- Cradle the fish when holding rather than holding by the tail to prevent spinal damage.
- Rest fish on a wet foam mat to prevent damage to the meat.
- A wet towel over the eyes will minimise stress.
- Make sure the tuna is gently placed back into the water rather than speared headfirst.

Preserving quality of the fish:

- Unless you have the capacity to care for your caught fish (to ensure the animal doesn't go to waste), you should not be keeping it.
- Brain spike is a quick and humane way of dispatching a fish and the first step to the 'Ike Jime' process.
- Bleeding a fish ensures the meat has flavour as well as removing unnecessary mass.
- Pith the fish to prevent the fish heating itself.
- The fish can then be gilled and gutted.
- It is critical to begin chilling the fish as soon as possible. This process can take up to 48 hours. As a general rule you will require 1 kg of ice for every 1 kg of flesh, and ice will need to be replenished.

Shellfish

Shellfish are legally considered to be taken when they cannot freely return to the water. This includes when placed into a catch bag or stored in a holding pot. At no time while gathering shellfish may fishers take or be in possession of more than the legal daily limit.

Table 4: Individual limits for shellfish species in the Fiordland Marine Area

Shellfish species	Maximum daily limit per active fisher		Minimum size
	Fiordland Marine Area (outside the Fiords)	The Fiords' waters	
Cockles	20		None
Kina (sea egg)	30		None
Mussels	10		None
Oysters – flat/dredge [†]	No take allowed		
Pāua – ordinary/blackfoot*	5	2	125 mm
Pāua – yellowfoot*	2		80 mm
Pipi	20		None
Scallops [†]	No take allowed		
All other shellfish (combined)*	20		–

[†] Prohibited to take or possess any flat/dredge oysters or scallops taken from within the Fiordland Marine Area.

* Pāua daily limit beyond one day maximum cannot be accumulated within the Fiordland Marine Area. Possession of any blackfoot pāua taken from inside the Fiords must be counted together with any blackfoot pāua that was taken from outside the Fiords and are not additional to the maximum species limit of five.

• This is a combined mixed-species bag limit (whether same or different species for which a specific limit is not specified in table 4). It applies to all shellfish species not specifically named in table 4 and includes all crabs, cat's eye, cook's turban, limpets, periwinkles, starfish, and freshwater crayfish/koura.

How to measure pāua



Measure the greatest length of the shell in a straight line, parallel to the underside pāua foot (ventral surface). Do not measure over the curve of the shell.

Shellfish to be landed in a measurable state

All shellfish to which a minimum size restriction applies (including pāua):

- must be landed in the shell in a measurable state
- cannot be shucked or shelled seaward of the mean high-water mark. This includes transporting shellfish catch on the water.

Shellfish restrictions

Scallop and dredge oyster prohibition

No person may take or possess any scallops or flat/dredge oysters taken from within the Fiordland Marine Area due to species low abundance.

Dredges prohibited

It is prohibited to use or possess any shellfish dredge in the Fiordland Marine Area.

Underwater breathing apparatus

It is unlawful to:

- take any pāua using underwater breathing apparatus. This does not include snorkels
- be in possession of pāua while in possession of underwater breathing apparatus. This includes possession, in, or on, any vessel, aircraft (including helicopter), or vehicle.

Pāua

The endemic abalone species blackfoot pāua *Haliotis iris* is most abundant in exposed sites on the outer Fiordland coast and near the fiord entrances. Pāua is absent from the inner fiords, likely due to low wave energy, low salinity, and low seaweed and kelp growth (upon which pāua feed).



Blackfoot pāua. Photo: Louise Bennett-Jones

Pāua traits

Pāua begin to reproduce from age 3–5 years, which in southern waters equates to around 85–90 mm in length. Pāua are broadcast spawners, which means they reproduce by expelling sperm and eggs into the water column. For fertilisation to occur, the sperm and eggs need to combine. Successful fertilisation therefore requires high density clusters of adults living close together on the reef. When populations get harvested down to the state where there are no longer high-density patches of pāua, reproductive success is reduced, decreasing recruitment to the fishery.

The smaller yellowfoot pāua *Haliotis australis* also inhabits the Fiordland coast but is considerably less abundant. Yellowfoot pāua have a similar life history to blackfoot pāua, and have an algae-based diet. Individuals rarely exceed 110 mm in length.

Pāua fishery

Fiordland has had an important commercial fishery for blackfoot pāua for many years. The management of the commercial fishery has improved in recent years, driven by the sector, and informed by ongoing research and monitoring of catch and effort. Whilst commercial fishers are allowed to work the fiord entrances up to the habitat lines, the majority of the fishing effort is focused on the open coast due to the larger pāua and higher abundance generally.

The commercial pāua industry is managed under the PAU 5 fishery plan, approved by the Minister for Oceans and Fisheries under section 11A of the Fisheries Act. The plan sets out several voluntary initiatives implemented by the commercial industry where applicable. These include harvesting to a larger size than the legal minimum to preserve higher levels of spawning stock biomass and voluntary catch spreading initiatives on a small spatial scale. Additionally, the plan sets out shelving of Annual Catch Entitlement when required to rebuild the population to target levels, as well as active stock enhancement programmes.

Currently, blackfoot pāua are being taken from inside the fiords at a level that is unsustainable. Where once patches of pāua were common throughout Fiordland, they are now noticeably absent. Recreational fishing rules introduced in 2024 have restricted the individual daily limit to two in the Fiords' waters. It is hoped that by incentivising people to take pāua from the open coast, pāua will be given a chance to rebuild inside the fiords for future generations to enjoy.

Guidelines for gathering pāua

It is important to recognise that pāua less than the minimum legal size are next year's harvest and contribute to the population by reproducing. Often these pāua are removed and damaged by recreational pāua collectors, only to be returned to the sea to die. Despite their ability to thrive on high energy coastline, pāua are extremely vulnerable to damage that can occur during harvest.

They are haemophiliacs, having no blood clotting mechanism. Damage caused to the muscular foot often leads to death.

Here are some ways you can collect pāua with care:

- Use a flat-bladed tool or dive knife to remove pāua, avoiding sharp-blade and tipped instruments including screwdrivers. Ideally, use a purpose-made plastic pāua knife that incorporates a flat blade. If unsuccessful in removing a pāua on the first attempt, leave it, because if it has clamped onto a rock, it is extremely unlikely it will be prised loose without suffering damage.
- It is best practise to measure pāua underwater using a tool that incorporates a 125 mm mark. This will decrease the chance of taking and damaging undersized pāua. MPI Fisheries New Zealand distributes purpose-made plastic pāua knives with a measuring slot.
- If you have taken pāua out of the water to measure, do so immediately at the water's edge whilst keeping pāua damp and in the shade and return any undersized pāua to the water immediately. Heat-damaged pāua returned to the reef will be in a weakened state and are susceptible to predation.
- Ensure any returned pāua are placed right way up in suitable habitat (boulders or rock) to give them the best chance of avoiding predators. Do not throw them over the side of your boat.
- Be aware in the fiords of the freshwater layer when returning pāua as they will not survive in freshwater.
- Spread your fishing effort so as not to clear whole areas of legal-sized pāua as this will prevent local recruitment of juveniles.
- Underwater breathing apparatus is prohibited when collecting or in possession of pāua.
- Consider the future pāua harvest of yourselves and others by taking only what you need (within the confines of the daily bag limit).

Rock lobster (crayfish)

While Aotearoa has four species of marine crayfish, otherwise known as rock lobsters, only the red or spiny rock lobster *Jasus edwardsii* (kōura) is common throughout the fiords and outer coast. In fact, the cool waters surrounding the South Island southern coast and Fiordland are home to the largest abundance of spiny rock lobsters in Aotearoa. Far less common, the green or packhorse rock lobster *Sagmariasus verreauxi* can occasionally appear as far south as Foveaux Strait, but are more widespread in the North Island.

Rock lobster traits

Female rock lobster can carry more than half a million eggs under their tail for up to six months before they hatch into larvae. These larvae can spend over a year drifting the ocean currents as plankton, before settling onto reefs and growing up.

To grow, rock lobsters need to moult their shell and grow a new larger one. Initially, the new shell is soft, which makes the individual vulnerable to predators. After a few days, however, the shell hardens and over time it thickens and strengthens. Rock lobsters tend to reach legal size after 5–10 years and can live for more than 30 years.

Rock lobsters tend to take shelter in crevices and caves by day and search for food at night. They have a wide-ranging diet including shellfish, crabs, sea urchins, seaweeds and small fish.

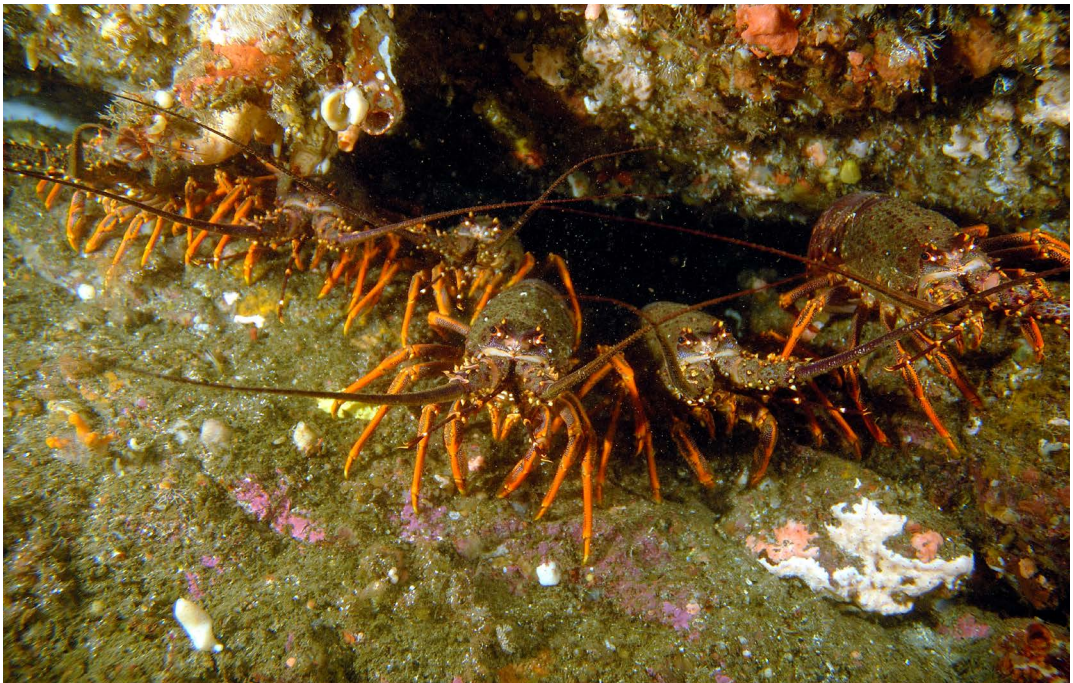

Rock lobster pack. Photo: Steve Wing

The commercial rock lobster fishery

The story of the commercial rock lobster industry in Fiordland is, ultimately, a good news story: the Fiordland rock lobster fishery today considered one of the most sustainable fisheries on the planet.

Since the industry began here in the late 1940s, the fishery went through a major boom and bust cycle, when there were few limits imposed on commercial catch. The sustainability of the fishery changed markedly from the late 1980s as a result of two major factors:

- the introduction of the Quota Management System in 1990
- a series of innovative changes to rock lobster fishing practice – many of which were developed by Fiordland lobster fishers (contributing a great deal of time and dedication), some of whom are Fiordland Marine Guardians today.

Today, the Fiordland lobster industry is the largest contributor to the New Zealand rock lobster export market, making a significant contribution to the local economy.

It was the lobster fishers who began the Guardians of Fiordland in 1995, and continue to take important positions around the board table, but also provide a critical eye on the place from which they not only derive their income, but show a great deal of care and responsibility.

Rock lobster fishing rules

A maximum daily bag limit of six rock lobster (both spiny and packhorse rock lobster species combined) applies in the Fiordland Marine Area including within the Fiords and the Internal Waters; but excluding the Piopiotahi/Milford Sound Internal Waters, which has a rock lobster limit of three, with no accumulation (table 5).

At no time while gathering rock lobster may fishers take or be in possession of more than the legal daily limit. Rock lobster are legally considered to be taken when they cannot freely return to the water. This includes when placed into a catch bag or stored in a holding pot.

Table 5: Individual daily limits for rock lobster in the Fiordland Marine Area

Rock lobster species	Fiordland Marine Area (outside the Fiords) Maximum daily limit per active fisher	The Fiords' waters Maximum daily limit per active fisher
Spiny red rock lobster and Packhorse rock lobsters combined	6	
Except Milford Sound Internal Waters – both species combined	3	

Limits on accumulation

Within the Fiordland Marine Area a special regulation defence provision allows fishers to possess and accumulate rock lobsters taken over three or more days in excess of the daily possession limit if:

- not more than 15 rock lobsters are possessed by an individual fisher
- the daily take limit of six rock lobsters was not exceeded on any day
- not more than three rock lobsters were taken from the Piopiotahi/Milford Sound Internal Waters
- rock lobsters held on board or landed from a vessel must have each fisher's daily catch held in separate containers or bags that are labelled to identify the individual fisher, the number of rock lobster and date taken.

In the case of rock lobster held temporarily in a holding pot at sea, the fisher must maintain and be able to immediately produce, upon the request of a fishery officer, a **legible written record** containing the:

1. individual fisher's full name
2. date on which the fisher took the rock lobster
3. number of rock lobster held in each rock lobster holding pot, including the number of rock lobster taken from within the Piopiotahi/Milford Sound Internal Waters
4. global positioning system (GPS) coordinates or physical location of each holding pot
5. date on which the fisher removed rock lobster from each holding pot
6. number of rock lobster removed from each holding pot.

In the case of rock lobster held on board or landed from a vessel, including rock lobster removed from any holding pot, the rock lobster must be held in labelled containers or bags that:

- contain only rock lobsters taken on a single day
- are clearly labelled to record the:
 - ▶ individual fisher's full name
 - ▶ date on which the rock lobster was taken by the fisher
 - ▶ number of rock lobsters held in the container or bag
 - ▶ number of rock lobsters (if any) taken from the Piopiotahi/Milford Sound Internal Waters.



Accumulation of rock lobsters beyond an individual fisher's daily limit of six is conditional on each individual fisher's daily catch separation and container labelling requirements being met.

Failure to comply with the regulation conditions risks any accumulated rock lobsters beyond the six daily limit being confiscated and returned to the water by fishery officers, along with receiving an infringement notice for exceeding the rock lobster possession limit.

Measurable state

It is unlawful to possess rock lobster or any rock lobster tail in an unmeasurable state seaward of the mean high-water mark or to land any unmeasurable rock lobster from a fishing vessel.

Rock lobster minimum sizes

The following rock lobster species minimum tail width size limits apply:

- male spiny rock lobster minimum tail width 54 mm
- female spiny rock lobster minimum tail width 60 mm
- male packhorse rock lobster minimum tail width 84 mm
- female packhorse rock lobster minimum tail width 90 mm.

Measuring rock lobsters

When measuring rock lobster, measure the tail width in a straight line between the tips of the two large (primary) spines on the second segment of the tail (as shown in the diagram).



Measuring a female spiny rock lobster tail width using a Ministry for Primary Industries gauge. Photo: MPI

The sex is easily determined:

- females have small pincers on the rear pair of legs
- pleopods are in paired form on each side of the under surface of female tails and are in single form in male tails.

If you are unsure of the sex of lobster, assume it is female (which have the larger minimum size requirements).

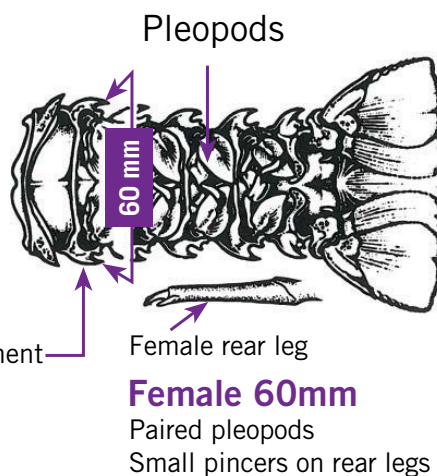
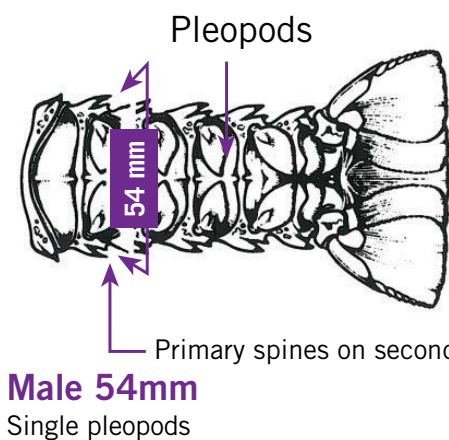

Guide for measuring the size of male and female spiny rock lobster. Note that packhorse rock lobster have different minimum size limits.

Protected rock lobster

The following types of rock lobster must be **immediately** returned to the water and cannot be legally possessed:

- undersized rock lobster
- female rock lobster carrying external eggs (in berry) – these are carried between the pleopods on the underside of the tail
- any rock lobster in the soft-shell stage (following moulting where the exoskeleton has not reached full hardness)
- rock lobster that cannot be measured accurately because of damage to the tail preventing accurate measurement. This includes fracturing of the calcified bar or any part of the tail exoskeleton of the second abdominal segment; or any broken tips of the primary pleural spines of the second abdominal segment.

Prohibited gathering methods

When catching rock lobster it is unlawful to:

- possess rock lobster or any rock lobster tail in an unmeasurable state seaward of the high-water mark
- remove external eggs or the egg-bearing appendages from any female rock lobster or to possess any rock lobster that have had external eggs removed by artificial means
- use a spear or device that could puncture the exoskeleton (body shell)
- possess any rock lobster that has been speared or punctured
- use a spring-loaded or trigger-mechanism loop or lasso device that is likely to puncture, penetrate, cut or otherwise damage the rock lobster body or tail. These devices are prohibited
- use or set a baited net for taking rock lobsters, or possess any rock lobster with a baited net.

However, it is lawful to use:

- hand-operated loops or lassoes
- a hand-pulled bob or ring pot.

Rock lobster catching and holding pot restrictions

Rock lobster holding pots and rock lobster (catching) pots can be used in the Fiordland Marine Area. This is one of the few places in Aotearoa where holding pots are lawfully provided for and regularly used by recreational fishers. Due to the area's remoteness and access constraints, holding pots are a practical solution to the absence of freezer storage.

Rock lobster pot means any pot, baited or not, that can catch or hold rock lobster. It includes any other device capable of catching, holding or storing rock lobster except a loop, bob or ring pot.

Rock lobster pot limits

Within the Fiordland Marine Area the following pot limits apply:

- All pots, and surface buoys or floats attached to the pot and float line, must be legibly and permanently marked with the person's initials and surname. This includes possession on any vessel.
- An individual may use, set or possess up to three rock lobster (catching) pots in any one day.
- If two or more persons are on a vessel in the Fiordland Marine Area, the maximum vessel rock lobster catching pot limit is three pots within a six pots vessel limit: being any lawful combination of species-specific catching pots and no more than three rock lobster catching pots and up to two rock lobster holding pots.

Please refer to the **Pendulo Reach prohibited potting area map** on page 111 in the 'Fiord-by-fiord guide' section.

Escape gaps

Rock lobster pot escape gaps or apertures are designed to allow undersized rock lobsters to escape from the pot. Escape gaps or apertures must not be in the top or bottom of a pot.

- **Round or beehive pots** must have at least three escape gaps or apertures (other than the mouth). Each aperture must have an inside dimension no smaller than **54 mm x 200 mm**.
- **Square or rectangular pots** must have at least two escape gaps or apertures (other than the mouth) in opposite faces of the pot. Each aperture shall not be less than 80 per cent of the height or length of the face of the pot in which the apertures are contained. Each aperture must have an inside dimension no smaller than **54 mm x 200 mm**.
- **Mesh pots** constructed entirely of unaltered spot-welded mesh with inside dimensions of **54 mm x 140 mm** do not have to have escape gaps or apertures. Mesh pots may be used with covers or liners, provided they leave at least 80 per cent of the surface area of each of two opposite sides unencumbered.

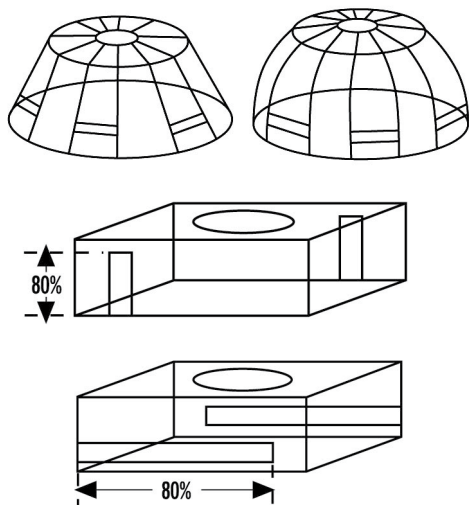

Rock lobster pots.

Rock lobster holding pots

A rock lobster holding pot is a pot that is used, or can be used, for holding or storing rock lobster but does

not include any pot that is capable of catching rock lobster. Within the Fiordland Marine Area, specific provision allows the use of rock lobster holding pots in addition to rock lobster catching pots. Holding pots are excluded from escape gap requirements.

The following restrictions apply:

- A limit of one holding pot per person, or a maximum of two holding pots per vessel if there are two or more persons on board.
- Holding pots and attached surface floats used from or transported on a vessel must be clearly and permanently marked with the vessel name and the characters HP1 for the first holding pot and (if applicable) HP2 for the second holding pot.
- Holding pots and attached surface floats used other than from a vessel must be clearly and permanently marked with the fisher's surname, initials and the characters HP.

Guidelines for handling rock lobster

Always handle rock lobster with care. Points to remember are:

- Avoid grasping rock lobsters by their legs or the antennae. Legs and feelers are easily detached and injured lobsters seldom survive.
- From mid-May through to the end of October female rock lobsters carry eggs – take care when handling lobsters during this time.
- Seasonal moulting (where they shed their outer shell) generally occurs for males from August to November and for females from February to July. During moulting, divers and fishers must avoid taking any soft-shell-stage rock lobsters where the new exoskeleton has not reached full hardness.
- Pots should not be left baited and unattended for more than 24 hours. Octopus can enter pots and will kill any rock lobsters that cannot escape.
- Special care should be taken to immediately return to the water all rock lobsters that are undersize or in an unlawful state. It is important to return rock lobster in close vicinity to suitable habitat to reduce the vulnerability to predation as they swim to shelter.

What can you do to look after the rock lobster fishery?

The sustainable management of our rock lobster fisheries is supported by an extensive scientific research programme, active stewardship by the local CRA8 industry, and enforcement by MPI fishery officers. See 'Tagging' section.

It is important for all fishers to follow the regulations and use proper catching and handling practices to ensure there will be plenty of rock lobsters for future generations.

Rock lobsters that must be returned to the sea by law should be put back immediately and carefully to maximise their chances of survival. Place them in an appropriate area, for example on to foul ground such as a reef, and not on to the exposed bottom in the middle of the fiord.

Support the rock lobster tagging programme

The New Zealand Rock Lobster Industry Council provides research services to the Ministry for Primary Industries and has an extensive rock lobster stock monitoring and research project, which includes a lobster-tagging programme.

The tagging programme is designed to find out more about the growth, distribution and seasonal patterns in abundance and size of rock lobsters, and lobster movement inside management areas.

Rock lobsters increase in size each time they moult (shed their shell and grow a new one). Smaller rock lobsters can moult several times in one season, while older and larger lobsters moult less frequently. Mature female lobsters also grow more slowly than male lobsters because they use a lot of energy bearing eggs.

Tagging

When a lobster is tagged, the sex, maturity, body length, tail width, and number of injuries (such as missing legs) are recorded. Five per cent are double tagged to get an idea of possible tag loss.

Tags are inserted into the tissue between the body and tail. This means the tag will stay in place, even when the lobster moults, and also enables the tag to be clearly visible.

Lobsters are released after tagging, and the location and water depth are recorded. Every attempt is made to release the lobster as close as possible to where it was caught. Global positioning systems are used to record positions.

Recapture

Recapture of tagged lobsters can give us information on growth and movement. Because the researchers will not normally be present when recaptures occur, they appreciate all lobster fishers providing help in returning information to them on Amateur Tag Recapture cards.

These cards are available from the New Zealand Rock Lobster Industry Council (phone (04 385 4005) or from any Ministry for Primary Industries office. See '**Contact information**', page 141.

When tagged lobsters (both legal and illegal) are caught, the researchers would like you to record the following details:

- sex
- tail width
- number of injuries (the number of missing legs and antennae, or severe damage such as horns missing or holes in the body)
- tag number(s) and prefix (the prefix is important as there are several tagging programmes around the country and a tag number can be duplicated)
- depth
- position
- whether you retain or release the lobster.

While many tagged lobsters are reported by fishers, some tags escape detection and are only noticed when the catch is cooked and served as a meal. The prefix in these cases identifies the source of the tag. It is also important to record both tag numbers if there are two tags.

If the lobster is under minimum legal size or carrying eggs it must be returned to the water. You may choose to re-release a legal lobster, and the additional information when it is caught again will be very useful. When a tagged lobster is re-released, please record the position and depth.

It is important when completing forms that the information is accurate. Please try to enter all required data. If you are not sure, leave the box blank and write a note on the form regarding the details. It is easier for someone to check with you later, than it is to fix 'wrong' data. Send tag data to:

New Zealand Rock Lobster Industry Council
Private Bag 24-901, Wellington 6142
Email: lobster@seafood.co.nz

Reporting suspicious or illegal fishing activity

Observe, record and report

It is illegal to sell, offer to sell, or trade your recreational or customary fish catch. If you see or hear of people acting illegally by taking more than their daily limit, or taking undersized fish, or if you are suspicious about the fishing activity of a person or a group of people, please report what you have seen to the Ministry for Primary Industries by calling the 0800 4 POACHER (0800 476 224) call-free number as soon as you can.

If possible, record or memorise the following information:

- exact location, time and date
- vessel name and numbers, and a description of vessel type, colour and length
- vehicle registration and a description of the make, model and colour
- number and description of people involved (and names and addresses if known)
- the details of what you observed, heard about, or found.

Any information provided in confidence to the Ministry for Primary Industries will remain confidential.

Do not confront a suspected offender – only a fishery officer or a police officer have the lawful powers to stop, inspect and seize fish and property as evidence for fisheries offences.

Instead, if you can, discreetly take a photograph, note down key information, and report the matter by calling 0800 4 POACHER (0800 476 224), or notify the nearest MPI Fisheries New Zealand office as soon as possible.

Penalties

MPI Fisheries New Zealand does its best to make sure everyone who fishes knows the rules and sticks to them.

The law allows MPI to issue an infringement notice or to initiate prosecution of people who put themselves first and New Zealand fish stocks second.

There are graduated infringement notice penalties of \$250 and \$500 for breaches that are deemed less serious, and a maximum court fine of \$10,000.

For serious non-commercial offences, such as exceeding maximum species limits by more than three times the limit, there are maximum Court fines of \$20,000 and \$250,000 along with automatic forfeiture of any fish, gear and property (including vessels and vehicles) used in the offence.

To avoid a fisheries infringement or fine:

- know and observe fish species daily bag and minimum size limits
- be sure you know how to correctly measure your catch
- only use lawful fishing gear
- observe any species closed seasons and area restrictions.

Check the rules before going fishing

As amateur fishing regulations are subject to change without notice, it is important for recreational fishers intending to visit Fiordland to keep up to date by checking the current fishing rules before leaving home. Here are some simple ways you can do this.

Download the MPI free **NZ Fishing Rules** app by texting the word 'app' to 9889. It is important to do this before you leave home when you have cell phone coverage, as there is no reliable cell coverage beyond Te Anau or Manapouri. The downloaded app on your phone will then work even when you don't have coverage.

Visit www.fisheries.govt.nz/rules to read, print or order a copy of the *Fiordland Marine Area recreational fishing rules* brochure.

Further information

For more information on Fiordland's fishing rules, contact the MPI National Communications Centre, phone 0800 00 83 33, or the Invercargill MPI Fisheries New Zealand office, phone (03) 211 0060, to request a *Fiordland Marine Area recreational fishing rules* brochure or speak to a fishery officer. See '**Contact information**', page 141.

Commercial fishing regulations

In April 2005, the Fiordland Marine Area was established with the enactment of the Fiordland (Te Moana o Atawhenua) Marine Management Act 2005. The Act was the culmination of eight years collaborative work by the Guardians of Fiordland Fisheries and Marine Environment Inc. in developing a comprehensive Marine Conservation Strategy.

Throughout the original Guardian's journey from 1995 several commercial fisher representatives, (in particular CRA8), were at the forefront of the conservation strategy development in close collaboration with the other stakeholder representatives.

As a result of collective agreement following careful deliberations of the various fisheries issues and best management options, new fisheries regulations were enacted in June 2005. This involved amendments to both the commercial and amateur fishing regulations.

The following is a summary of several relevant commercial fishing regulations that are contained in the Fisheries (Southland and Sub-Antarctic Areas Commercial Fishing) Regulations 1986.

Internal Waters of Fiordland – commercial fishing prohibition

All commercial fishing is totally prohibited within the defined Internal Waters of Fiordland, which applies to 15 named fiords. Please see the 'Fiord-by-fiord guide' section for the series of fiord maps, which illustrate the respective fiord Internal Waters and boundary line coordinates.

Commercial fishers retain the full right of navigation passage, transit, shelter and anchorage throughout Fiordland's Internal Waters.

In addition, certain activities are permitted in relation to:

- holding live rock lobster in holding pots (cages)
- storing empty holding pots and empty rock lobster pots.

This does not include any pot that is capable of catching rock lobster with the pot doors shut and baited up.

Piopiotahi/Milford Sound entrance waters – commercial fishing prohibition

In Piopiotahi/Milford Sound waters seaward of Dale Point and the Internal Waters of the fiord, all commercial fishing is further prohibited between St Anne Point and Stripe Point, under regulation 3 (1)(a) of the Fisheries (Southland and Sub-Antarctic Areas Commercial Fishing) Regulations 1986.

This is a long-standing regulation dating back to the early years of the Fiordland rock lobster fishery. While the commercial fishing take prohibition prevents the commercial harvesting of finfish and shellfish, including pāua and rock lobster, CRA8 Rock lobster fishers are permitted to use coff holding pots to temporarily hold rock lobsters and to store open door unbaited catching pots in Anita and Fox Bays as well as inside the Internal Waters of Piopiotahi/Milford Sound.

Pot storage in marine reserves

The Fiordland (Te Moana o Atawhenua) Marine Management Act 2005 provides for five rock lobster pot storage areas in the following four marine reserves:

- Hāwea (Clio Rocks) Marine Reserve
- Kahukura (Gold Arm) Marine Reserve
- Taumoana (Five Finger Peninsula) Marine Reserve
- Te Tapuwae o Hua (Long Sound) Marine Reserve (two storage areas).

The permitted activity allows for commercial rock lobster holding (coff) pots containing live rock lobsters caught from outside the marine reserve to be temporarily stored and held for up to two months in designated storage areas. It also permits the storage of unbaited catching pots with all doors open and any empty holding pots.

For further details, including coordinates for the five pot storage areas, see the relevant fiord map illustrations in the **'Fiord-by-fiord guide'** section.



Commercial rock lobster fishermen in action. Photo: Graeme Dainty

Certain commercial fishing methods prohibited within the Fiords

There are seven commercial bulk fishing methods that are prohibited to use inside:

- Hāwea/Bligh Sound
- Te Houhou/George Sound
- Taitetimu/Caswell Sound
- Taiporoporo/Charles Sound
- Hinenui/Nancy Sound
- Te Awa-o-Tū/Thompson Sound
- Kaikiekie/Bradshaw Sound
- Patea/Doubtful Sound
- Te Rā/Dagg Sound
- Te Puaitaha/Breaksea Sound
- Tamatea/Dusky Sound
- Taiari/Chalky Inlet
- Rakituma/Preservation Inlet.

The prohibited areas inside each fiord are bounded by lines drawn between each of the fiords' natural outer entrance headlands. Prohibited methods include all commercial box or teichi net, purse seine net, Danish seine, trawl net, lampara net, or set nets of a total length exceeding 1,000 metres.

Section 111 General and Particular Approvals

Commercial fishers are permitted to take recreational fish catch using a registered commercial vessel if they hold a valid section 111 General Approval, or a Particular Approval issued under section 111 of the Fisheries Act 1996.

All recreational catch taken under a Section 111 General Approval by the registered fishing vessel skipper and crew is limited to one days recreational entitlement, irrespective of the fishing trip being over several days. Any Section 111 crew feed landings must be electronically recorded and reported to MPI Fisheries New Zealand via FishServe, fishserve.co.nz.

Amateur-fishing charter vessel operator registration and reporting

All charter boats that offer recreational fishing to their clients must be registered as an amateur-fishing charter vessel operator with Fisheries New Zealand.

The Fisheries (Amateur Fishing) Regulations 2013 defines an amateur-fishing charter vessel operator as any person who receives payment or benefit to provide a vessel and a fishing guide (service) to take (non-commercial) fishers on fishing trips.

Registered amateur fishing charter vessels are required to record and report all catch to Fisheries New Zealand, via FINNZ, which is a subsidiary of FishServe, Wellington.

The main purpose of the national amateur-fishing charter vessel operator registration and reporting regime is to regulate and compel charter vessel operators to provide MPI via FINNZ with reliable recreational fishing data to quantify and enable assessment of recreational fish catch and activity. The paper-based Activity Catch Return books are required to be progressively completed during each day of a charter fishing trip.

The activity catch data provided is vitally important. It allows Fisheries New Zealand inshore fisheries analysts and the Fiordland Marine Guardians to monitor and gauge harvest levels to help them make decisions about the appropriateness of sustainability measures' regulations.

There are infringement breaches for failing to comply with amateur-fishing charter vessel operator reporting obligations, and a maximum Court fine of \$10,000 for operating as an amateur-fishing charter vessel operator when not registered.

Fiord-by-fiord guide



Te Hokiauau/Big Bay area

The area around Te Hokiauau/Big Bay, and particularly Whakatipu Waitai/Martins Bay, was an important settlement site for Māori between 1650 and 1800. It provided easy access to food resources in the nearby lakes, sea and forests, as well as sought-after pounamu (greenstone). From the 1870s, Martins Bay also became home to European settlers. There are areas of Martins Bay around the short-lived Jamestown settlement that still have roses and sycamore trees – reminders of the pioneer farming settlement’s failure due to its extreme isolation.

Navigation

Heading north from Te Hokiauau/Big Bay it is advisable to stay one nautical mile offshore to avoid a rock that extends three-quarters of a nautical mile offshore on North Reef.

Heading south from Te Hokiauau/Big Bay it is advisable to be three-quarters of a nautical mile offshore to avoid South Reef.

If intending to cross the Martins Bay bar, please be aware that its position has changed markedly since the February 2020 floods. The entrance to the lower Hollyford River is now halfway down the beach and can be shallow and unpredictable depending on tide and weather. It is advisable that anyone crossing the bar without prior experience first consult someone with local knowledge.

When travelling from Te Hokiauau/Big Bay to Piopiotahi/Milford Sound, keep in water deeper than 45 metres.

When heading into Piopiotahi/Milford Sound from the north, be aware of the three submerged rocks that lie around the Brig Rock and Yates Point area. During daylight hours it is safe to travel between Brig Rock and Yates Point; however, at night it is advisable to give Brig Rock a wide berth. Refer to Land Information New Zealand (LINZ) Chart 7622.

Anchorage

There are two anchorages in Te Hokiauau/Big Bay.

- The first anchorage is to the north side of Te Hokiauau/Big Bay, just east of Crayfish Rock and is to be used in northerly conditions.
- The second anchorage is on the south side towards the head of the southern end of the bay.

When using either anchorage, be aware of changes of wind through the night, as fast-moving fronts can quickly and dramatically change conditions in these exposed anchorages.

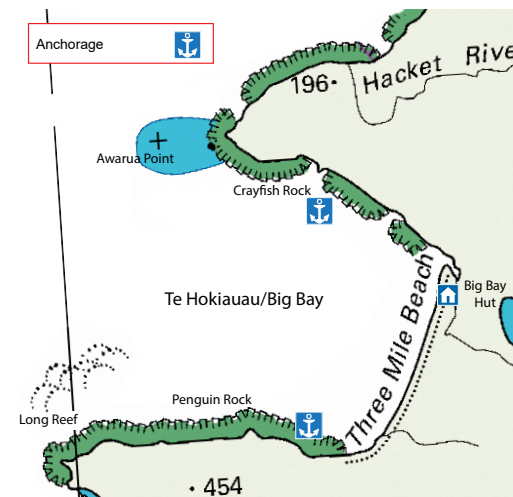

Te Hokiauau/Big Bay anchorages.

Huts

There are two Department of Conservation huts in the Te Hokiauau/Big Bay area: Big Bay hut sleeps nine and Martins Bay hut sleeps 24 people.

Piopiotahi/Milford Sound

Piopiotahi/Milford Sound is the northernmost and best known of all the fiords. The Māori name Piopiotahi means 'one piopio bird'. The piopio (now extinct) was a ground-feeding native thrush that declined rapidly after the introduction of mammalian predators.

This most dramatic of all fiords was missed by Captain Cook when he was heading north. The first European to find and name the fiord, in the 1820s, was sealing vessel captain John Grono, who was born near Milford Haven in Wales.

The sheer steep-sided walls of Piopiotahi/Milford Sound rise to 1,683 metres at Mitre Peak and over 2,700 metres in the surrounding Darran Mountains. The distance from the head of the fiord to the open sea is about 16 kilometres.

Piopiotahi/Milford Sound is the only fiord that can be reached directly by vehicle, and receives over 850,000 visitors a year. It is the main access point for tourist activities in the Fiordland Marine Area. There are boat launching facilities at Deep Water Basin and limited cell phone coverage in the village. The sheer numbers of people visiting Piopiotahi/Milford Sound means there is significant pressure on its marine environment.

Several lobster/cray fishers use Piopiotahi/Milford Sound, meaning there are many pots dotted between Greenstone Point and St Anne Point, and south of St Anne to the Transit. Please avoid them.

Navigation

The commercial tourism operators travel in a clockwise direction around the fiord. They head out along the southern wall and return against the northern wall.

Heading south from Piopiotahi/Milford Sound there is an area south/southwest of St Anne Point (shallow area highlighted on LINZ Chart 7622) that can break a long way offshore in a heavy south-west and westerly swell greater than 5 metres.

When travelling from Piopiotahi/Milford Sound to Papapounamu/Poison Bay, keep in water deeper than 45 metres.

Anchorage

Freshwater Basin

The wharves here are operated by Milford Sound Tourism and are for the sole use of commercial tourist boats operating from Piopiotahi/Milford Sound.

Deepwater Basin

This is the only place to get fuel in Fiordland until you reach Patea/Doubtful Sound, and water is also available. Diesel is available with an Allied Card or from the Fiordland Lobster Company manager for cash or internet banking.

When approaching the channel to Deepwater Basin, stay halfway between the port-hand markers and the western side of the channel. As a note of caution, care should be taken after heavy rains where the Arthur River joins the channel, as strong eddies (whirlpools) can be experienced here. There are two port and two starboard markers at this point going through to Deepwater Basin.

Keep to the middle of the channel through the markers, and do not turn to port to approach the berths until you are at least 100 metres past the last port-hand marker. Contact Fiordland Lobster Company on VHF Channel 67 to arrange a berth while in port.

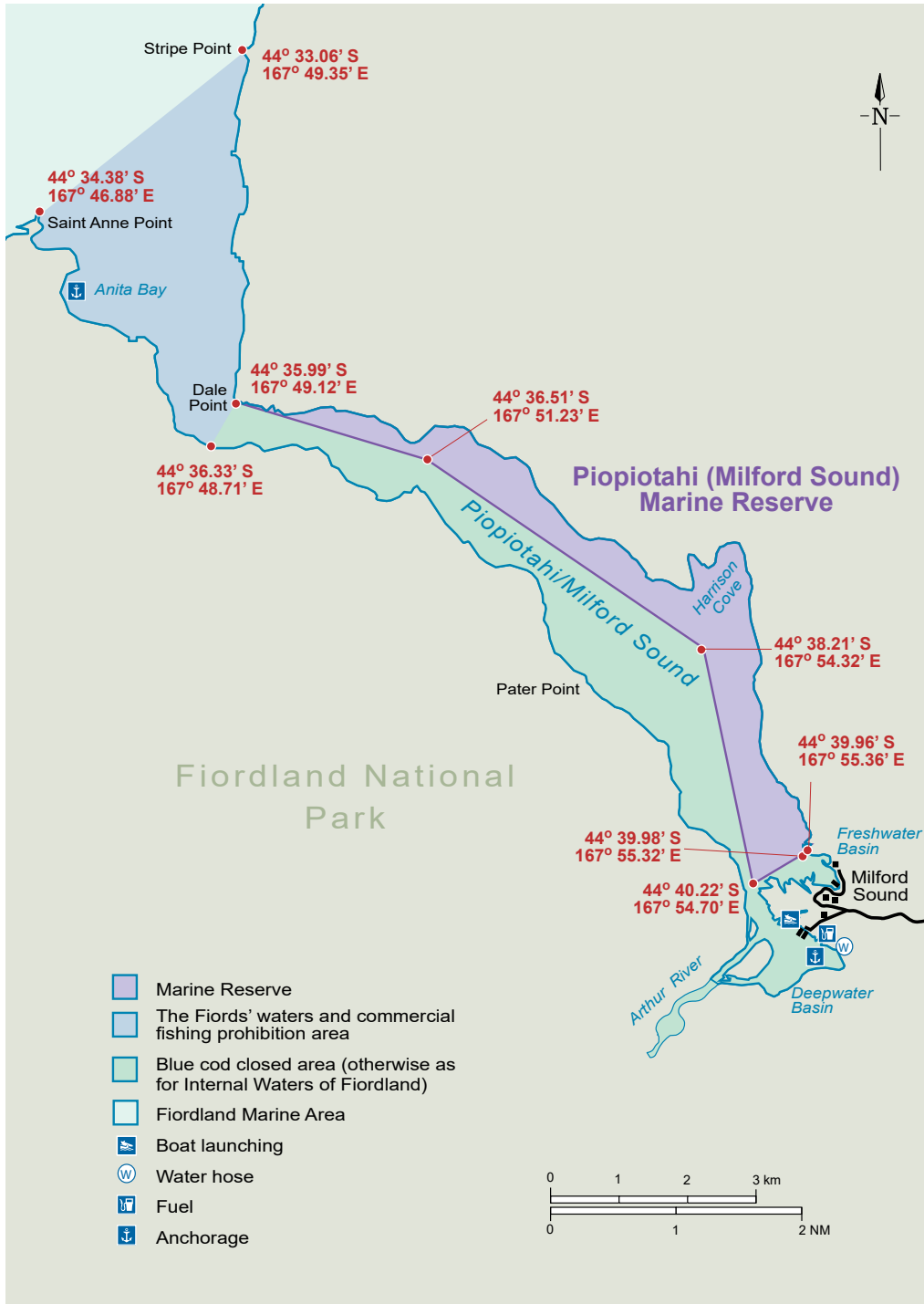

Piopiotahi/Milford Sound.

RealNZ owns two permanent moorings in Deepwater Basin that are suitable for vessels up to approximately 700 gross tonnes. RealNZ can be contacted to check availability of these moorings by contacting the Duty Manager on VHF Channel 8 within Piopiotahi/Milford Sound or by calling (03) 249 8090. You must complete a RealNZ Mooring Code of Practice document to use the moorings.

Please note that as a result of flood damage, the Cleddau River has shifted course with a large gravel bank moving closer to the wharf and posing a potential hazard.

Deepwater Basin contains a public boat ramp/launching area adjacent to the main wharf. The boat ramp is available for the public to launch boats but at times this boat ramp area can be very busy and congested.

There is some provision for daily parking; however, no long-term parking is permitted in the Deepwater Basin vicinity. Long-term boat storage (longer than 24 hours) may be arranged, dependent on availability, by contacting the Department of Conservation on (03) 249 0200.

Harrison Cove

Anchoring at Harrison Cove is only permitted at depths greater than 60 metres, and is generally not practical. There are several commercial moorings in Harrison Cove as part of commercial operations, including two permanent moorings owned by RealNZ. RealNZ can be contacted to check availability of these moorings (see contact information above), noting that the company's vessels use the moorings every night during September–May. Not suitable in strong northerly or westerly winds.

Anita Bay

This is a fair-weather anchorage only, close to Post Office Rock (named after the rum barrel that historically acted as a post box for the settlement of Milford). If you are anchoring here, it is essential to use a stern line. Not suitable for any easterly wind or strong northerly or westerly winds. Be aware of large number of lobster pots stored here.

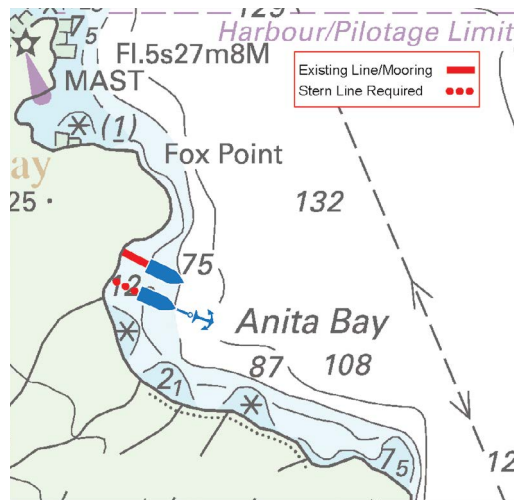

Anita Bay.

Fishing

It is **prohibited to take or possess blue cod** from the Internal Waters of this fiord, as these are either protected by the marine reserve on the northern side, or the blue cod closed area, See **map**, page 83.

For comprehensive fishing rules, see the '**Fisheries information and guidelines**' section.

Commercial fishing is prohibited in waters landward of the line that extends from Saint Anne Point to Stripe Point. However, commercial lobster pots are allowed to be stored in this area.

Marine Protected Area

Piopiotahi (Milford Sound) Marine Reserve

Piopiotahi Marine Reserve is situated along the northern side of Piopiotahi/Milford Sound, from the head of the fiord to Dale Point. The underwater habitats it covers are mostly deep muddy fiord basin, with a large section of deep reef and a small section of shallow rock wall along the shore.

There is very steep rock wall on the inner northern side of Piopiotahi/Milford Sound, which is dominated by delicate deep-water sessile invertebrates. These are animals that are fixed to the rock wall, including encrusting tubeworms, sponges, soft corals, colonial sea squirts, black coral, and anemones. Piopiotahi Marine Reserve is one of the most popular places in Fiordland to dive and see the black corals for which the fiords are famous.



Black coral and snakestar. Photo: SeacologyNZ.com / Irene and Crispin Middleton

Papapounamu/Poison Bay

See **map**, page 87.

The Māori name, Papapounamu, means ‘greenstone flat’. Its European name is derived from a story about an early sealer struck by food poisoning at the bay. Recently, it’s been discovered that hydrogen and methane gas seeps out of the rocks on the shoreline of Poison Bay, due to natural geological processes. Māori regarded this as a place where people should not go, possibly because of the presence of this gas.

Papapounamu/Poison Bay is a popular destination for day boats fishing from Piopiotahi/Milford Sound.

Navigation

When travelling from Papapounamu/Poison Bay to Te Hāpua/Sutherland Sound, keep in water deeper than 45 metres.

Anchorage

This bay is a fair-weather anchorage in east to southeast and lighter southwest conditions. Due to the exposed nature of the bay be mindful of weather changes during the night, especially a change to northwest conditions.

Te Hāpua/Sutherland Sound

Te Hāpua/Sutherland Sound is the fiord immediately south of Piopiotahi/Milford Sound. Māori know this fiord as Te Hāpua – the lagoon. During the *Acheron* survey in 1851, it was thought to be a small bay until, in 1883, Donald Sutherland sailed into it to explore and chart its full extent. Sutherland observed: “The lake abounds with fish and following them is no scarcity of sharks, which infest the tidal river and lake wherever fish are found.” (Hall-Jones, 2002)

Te Hāpua/Sutherland Sound is unique because of its estuarine nature and the whole fiord is a marine reserve. At low tide, a series of channels cross the extensive mud and sand flats. The shallow outer 4 kilometres of the fiord is constricted by forested flats and a sand spit at the entrance to the sea. This is the least modified and visited of all the fiords.

Te Hāpua/Sutherland Sound has never been commercially fished.

Navigation

When travelling from Te Hāpua/Sutherland Sound to Hāwea/Bligh Sound, keep in water deeper than 40 metres.

Anchorage

Anchoring is not advised. Te Hāpua/Sutherland Sound should not be entered without local knowledge, due to the shallow nature of the estuary and bar.

Marine Protected Area

Te Hāpua (Sutherland Sound) Marine Reserve

Access limitations make Te Hāpua Marine Reserve the least studied reserve in Fiordland but probably the most pristine. Ocean waves break across the shallow entrance in all but the very calmest of conditions. There have been few research trips to the reserve, but divers have observed a unique environment in the isolated basin, which is connected to the sea by a narrow channel.

Flatfish, spiky dogfish and stargazer can be observed in the fiord and crabs and starfish are abundant. There are no rock lobsters or pāua due to periodic low salinity.



Flounder (pātiki). Photo: Richard Kinsey, DOC

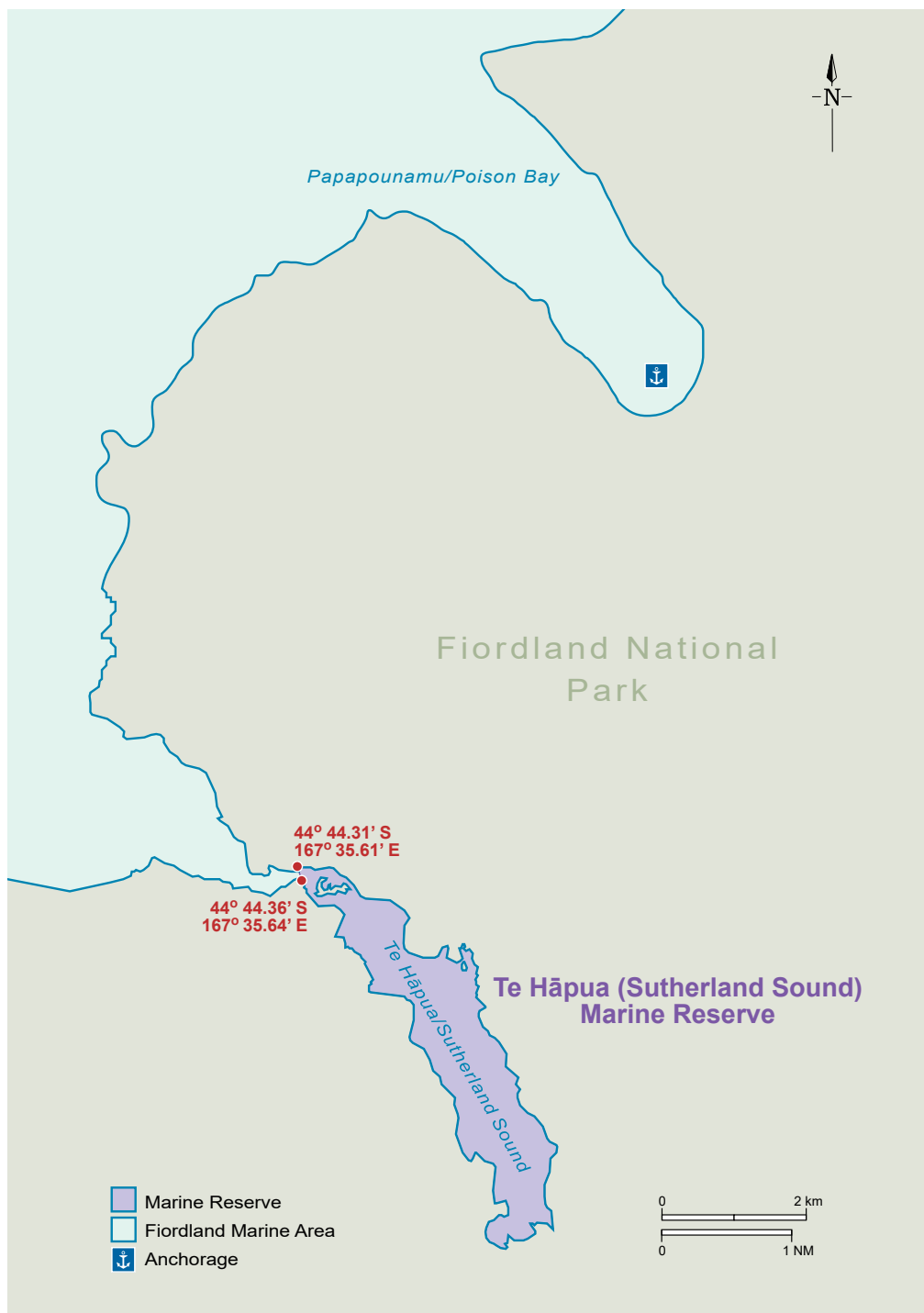

Te Hāpua/Sutherland Sound.

Hāwea/Bligh Sound

Hāwea was named after the ancient iwi of Kāti Hāwea. Kāti Hāwea was one of the earliest iwi to occupy Te Wāhipounamu/the South Island before the southern migrations of Kāti Māmoe and Ngāi Tahu. It was named 'Bligh Sound' by John Grono, the early sealer and frequent name-giver, after Governor Bligh of New South Wales, Australia. Grono's first command when he visited Fiordland in 1809 was on a ship called the *Governor Bligh*.

Hāwea/Bligh Sound has a wide entrance for a northern fiord and is relatively shallow (about 90 metres), until Turn Round Point where it suddenly deepens to over 180 metres. The fiord zigzags approximately 18 kilometres inland to the head at Wild Natives River.

The fiord has a rich early Māori history, with archaeological evidence of campsites and many associated Māori place names.

Navigation

The Clio Rocks are a navigational hazard. They lie between Turn Round Point and Evening Point on the southern side of Kelly's anchorage (see LINZ Chart 7623). When travelling from Hāwea/Bligh Sound to Te Houhou/George Sound, keep in water deeper than 40 metres.

Anchorage

There are no anchorages in this fiord that provide adequate shelter in moderate to bad weather.

Radio communication is available on Channel 66 for all the anchorages below.

Escape Cove

This is a fair-weather anchorage only and a stern line must be used. Note this anchorage is inside the marine reserve.

Kelly's

This is a good fair-weather anchorage, suitable for all winds in moderate conditions. A stern line is available, and its use is essential. Note this anchorage is inside the marine reserve.

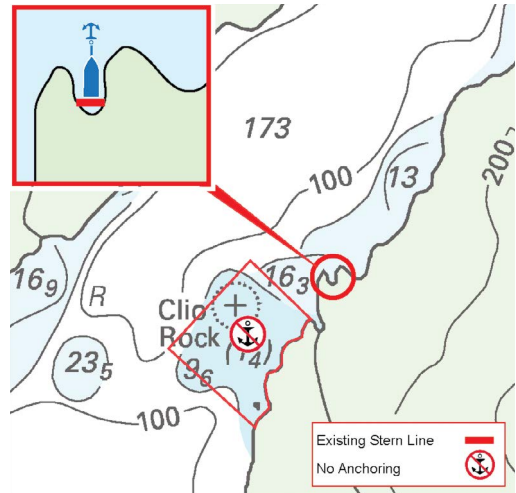

Kelly's.



Hāwea/Bligh Sound.

Amazon Cove

A good fair-weather anchorage, but be aware there is very little room for manoeuvrability. A stern line is available and essential.

Bounty Haven

This is the best anchorage in Hāwea/Bligh Sound in strong conditions and heavy winds. However, be warned that in very rough conditions even this anchorage is not fully sheltered. A stern line is available and essential.

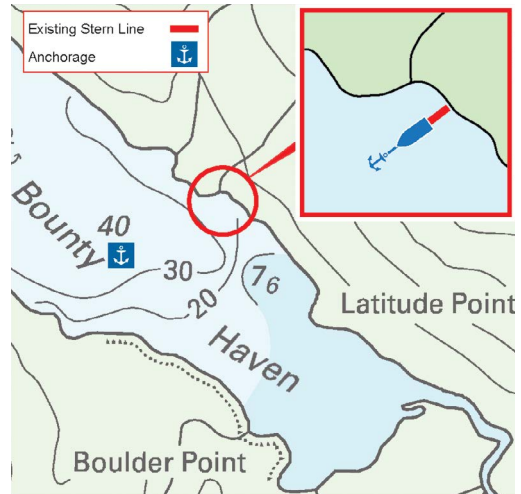

Bounty Haven.

Marine Protected Areas

Hāwea (Clio Rocks) Marine Reserve

Most of the reserve is made up of deep-basin habitat, but there are also large areas of sheltered shallow rock-wall and deep-reef habitats. Underwater mapping of the reserve shows mostly steep rock walls on the shaded western side of the reserve, compared with more broken rocky reefs on the reserve's more sunlit eastern side.

The near-vertical rock walls of Turn Round Point are a special feature of the reserve, with abundant reef fish and invertebrates feeding on plankton swept past in the high tidal flow.

Red and black corals are relatively abundant along the rock walls in this area. The north-eastern corner of the marine reserve is a designated area for commercial rock lobster holding and pot storage.

Clio Rocks china shop – no-anchoring area

This china shop is a unique and fragile habitat, with the Clio Rocks just 2 metres below the surface on the eastern side of the fiord, as compared to the surrounding depth of 220 metres in the middle of the fiord. An abundant community of delicate red and black corals is found here, which is why anchoring is not permitted.



Red coral. Photo: Jonathan Davies

Te Houhou/George Sound

The fiord's Māori name is Te Houhou, meaning five finger tree, *Pseudopanax arboreus*.

The European name, George Sound, was thought to have been derived from mariner George Stevens from Aparima/Riverton, who piloted the *Acheron* during its survey in 1851. It's also possible it was named by John Grono after one of his New South Wales neighbours, George Hall.

This is one of the longer fiords, at 21.2 kilometres. At the head of the fiord there are two short arms. The south-eastern arm has access to the Te Houhou/George Sound track, which winds through to the northwest arm of the middle fiord of Lake Te Anau. Te Houhou/George Sound is often the first stop after steaming south from Piopiotahi/Milford Sound, missing out Hāwea/Bligh Sound, as it has better anchorages and for many is a more interesting fiord.

Navigation

When travelling from Te Houhou/George Sound to Taitetimu/Caswell Sound, keep in water deeper than 40 metres to Looking Glass Bay. Looking Glass Bay offers a good fair-weather anchorage in the middle of the bay, down to approximately 9 metres of water.

From Looking Glass Bay to Taitetimu/Caswell Sound keep in water deeper than 50 metres.

Anchorages

Radio communication is available on Channel 66 for all the anchorages below.

Anchorage Cove

This anchorage is suitable for moderate weather conditions. Caution should be used with heavy swells from a westerly and northerly direction, as large surges will be experienced in this anchorage.

There is a stern line from the eastern shore joined to another line coming from the island. Anchoring is not necessary. A water hose is attached to the stern line. The head of the bay is very shallow, due to a gravel/sand bar extending out from the river mouth, so caution should be used when approaching the stern line. The stern line is not suitable for vessels of drafts more than 2 metres.

There is a general anchoring area in the middle of the bay for use in light winds.

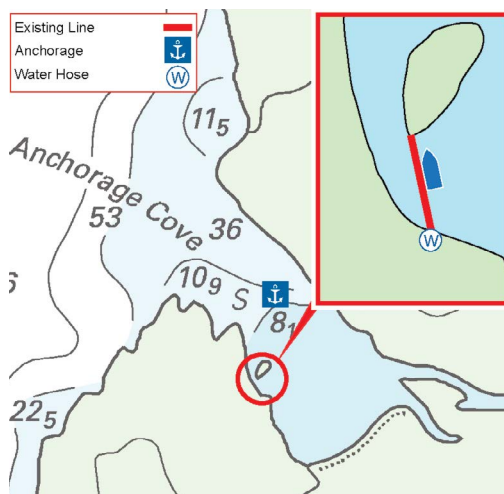

Anchorage Cove.

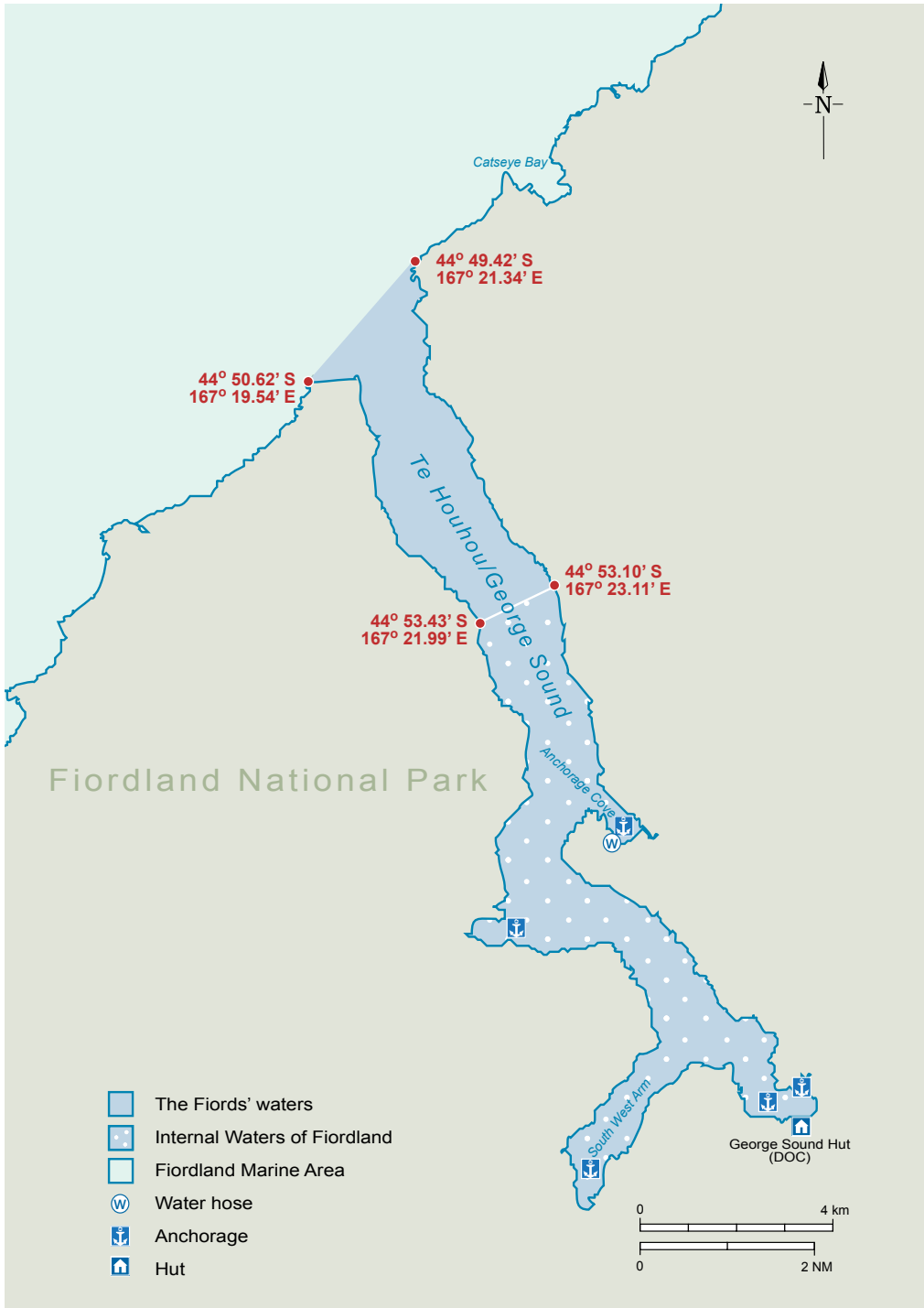

Te Houhou/George Sound.

Alice Falls

This is an all-weather anchorage, and the best anchorage in Te Houhou/George Sound in strong winds.

Caution should be used when anchoring here, especially during high rainfall, as the waterfall will push the vessel sideways while setting the anchor and retrieving the stern line. Be careful not to go too far back into the stern line as it shallows very rapidly.

While strong to violent winds can be experienced in this anchorage, if the anchor is of good quality and well set you will not be blown out.

Be aware of a rock at the head of the fiord that is marked on LINZ Chart 7623.

There is another anchorage that is suitable for light winds in the middle of the bay.

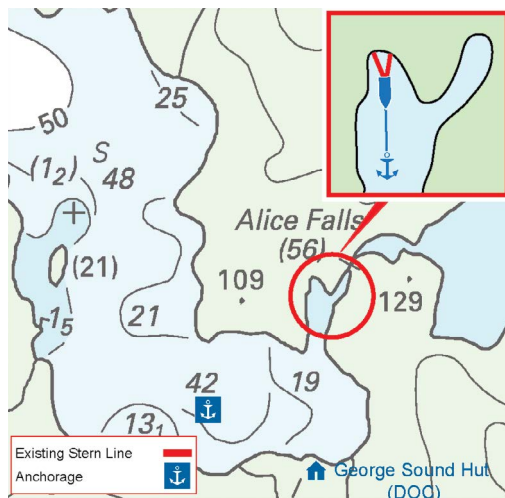

Alice Falls.

South West Arm

This is considered an all-weather anchorage; however, sea conditions will make this anchorage uncomfortable during high tide and strong winds. This is due to the loss of protection from the outlying breakwater (on the north-western tip of the anchorage), which is covered during high tide. Use of a stern line is essential.

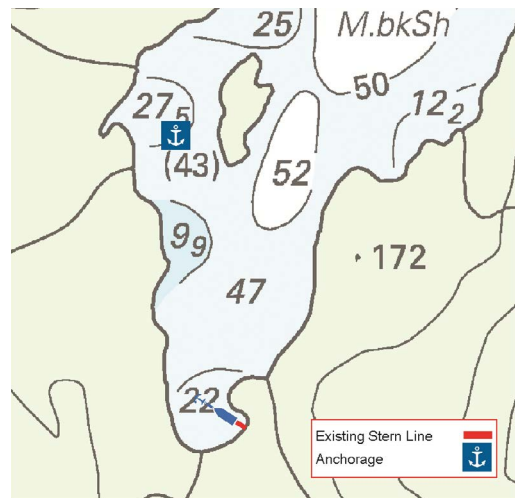

South West Arm.

Hut

The Te Houhou/George Sound hut is situated at the head of the fiord. This Department of Conservation hut sleeps eight people and is reasonably popular, year-round.

Taitetimu/Caswell Sound

Taitetimu/Caswell Sound is probably named after Lieutenant William Caswell. Caswell was another neighbour of John Grono from the Tanilba station in New South Wales. Taitetimu means the ebb tide, but also references a Māori tūpuna/ancestor, Taitetimu.

There is evidence on the southern side of the fiord of an old marble works (Caswell Sound Marble Works) that ran between 1882 and 1887.

The fiord is 15.7 kilometres long and has high, steep sides reaching up to some spectacular peaks. The Shirley Falls drops 365 metres from Lake Shirley on the fiord's southern side.

Navigation

There is a rock at the entrance to Taitetimu/Caswell Sound on the northern side (see LINZ Chart 7623). In heavy weather (southwest roll), the swell can break off the fiord wall and back out seawards from the rock. Extreme care is needed here in big swells as the entrance is very narrow.

When travelling from Taitetimu/Caswell Sound to Taiporoporo/Charles Sound, keep in water deeper than 45 metres.

Several rocks are present in Juno Bay (shown on LINZ Chart 7624), at the entrance to Taiporoporo/Charles Sound from the north. These rocks can be just under the water and very hard to see at high water in calm weather. Do not attempt a passage from the northwest side of the bay to the open coast because of unmarked rocks.

Anchorage

Radio communication is available on Channel 66 for all the anchorages below.

Head of fiord

This is a fair-weather anchorage. Be aware of the mud banks in the southeast corner, as they are not good for holding anchor.

Green Point

This is the best anchorage in strong winds in Taitetimu/Caswell Sound. Some swells may be experienced coming into the anchorage in strong winds. Use of a stern line is essential.

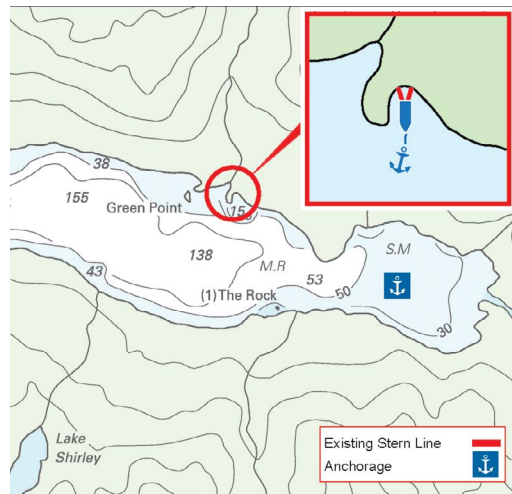

Green Point.

Hut

Taitetimu/Caswell Sound historic hut is a two-bunk hut and is located at the head of the fiord near the entrance of the Stillwater River. From the hut there is a scenic track along the Stillwater River that leads up to Lake Marchant.

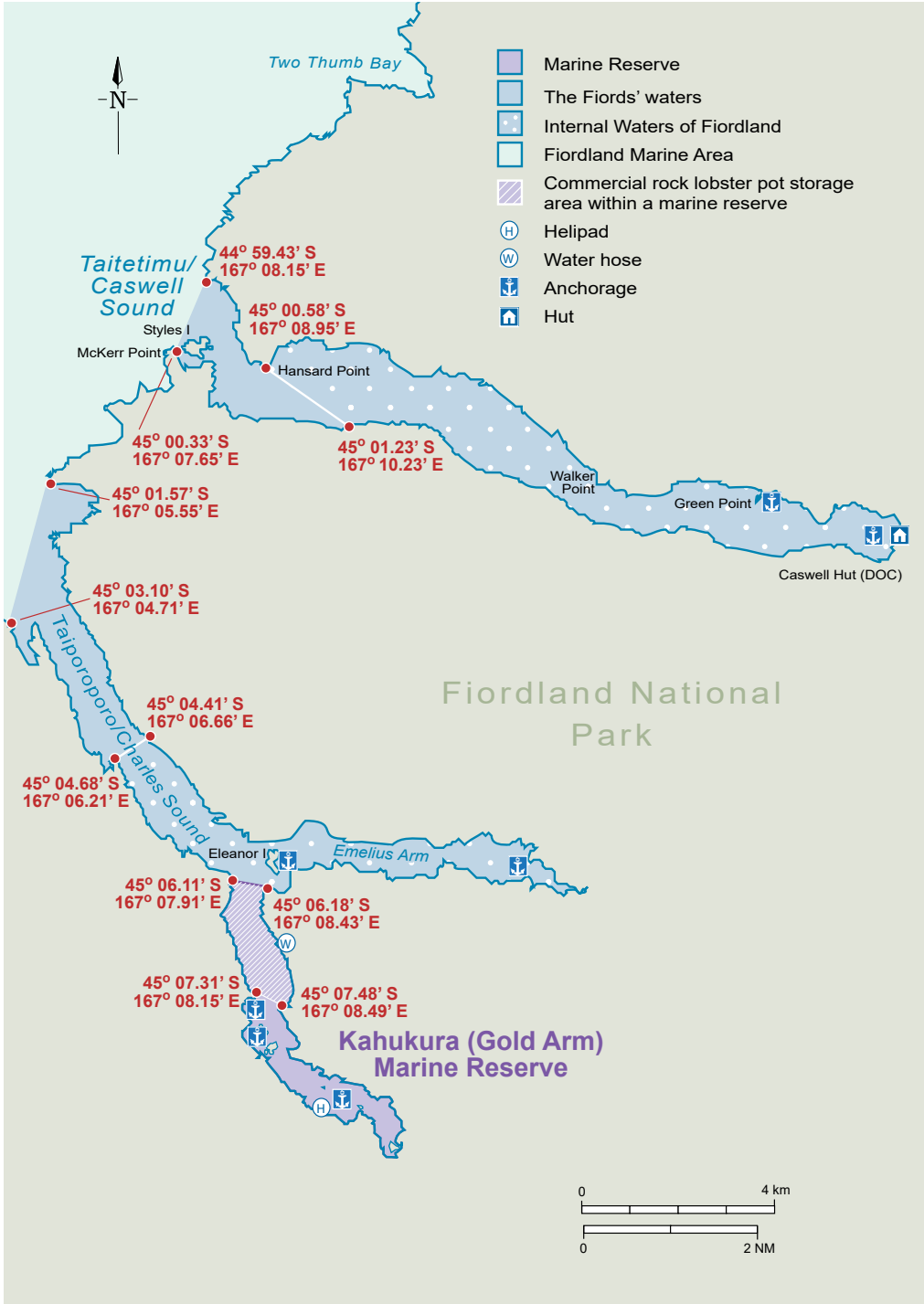

Taitetimu/Caswell Sound and Taiporoporo/Charles Sound.

Taiporoporo/Charles Sound

See **map**, page 95.

The Māori name, Taiporoporo, refers to a tūpuna/ ancestor who resided at Te Hokiauau/Big Bay. After suffering defeat at the hands of invading Ngāi Tahu, Taiporoporo and his brother, Taitetimu, escaped south. Taiporoporo was the name for Charles Sound, and his brother, Taitetimu, became the name for nearby Caswell Sound.

Taiporoporo/Charles Sound was known to early sealers as Charley's and is thought to be named after Charles McLaren who captained the sealing vessel *Sydney Cove* in 1810.

The fiord is 13.9 kilometres long and divides into two arms of equal length. Emelius Arm is fed by the Irene River, and Gold Arm by the Windward River. When the tide is high it's possible to take a dinghy approximately 2 to 3 kilometres up the Irene River. There are several small well-forested islands around the southern arm of the fiord.

Taiporoporo/Charles Sound is often the next stopping point from Te Houhou/George Sounds, as it has much better anchorages than those in Taitetimu/Caswell Sound.

Navigation

On approaching the Gold Arm anchorages, be aware of sunken rocks on the starboard side when entering the channel beside Fanny and Catherine Islands (see Catherine Island anchorage map).

When travelling from Taiporoporo/Charles Sound to Hinenui/Nancy Sound, keep in water deeper than 45 metres.

Anchorage

Radio communication is available on Channel 66 for all the anchorages below.

Eleanor Island

Not suitable in strong northerly to westerly conditions; tie alongside the rope going from the northern to the southern end of the cove.

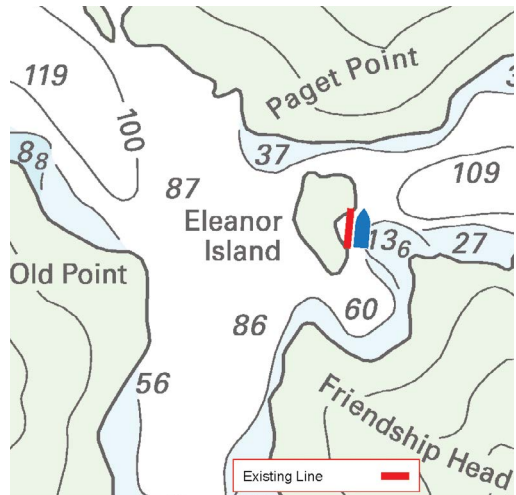

Eleanor Island.

Emelius Arm

For use in south-westerly and south-easterly conditions, and best for small vessels only. Not suitable in northerly and westerly conditions.

Catherine Island, Gold Arm

This is not suitable in strong easterly conditions; however, it is very good in strong westerly and northerly conditions. Tie alongside rope going from point to point, as shown on map.

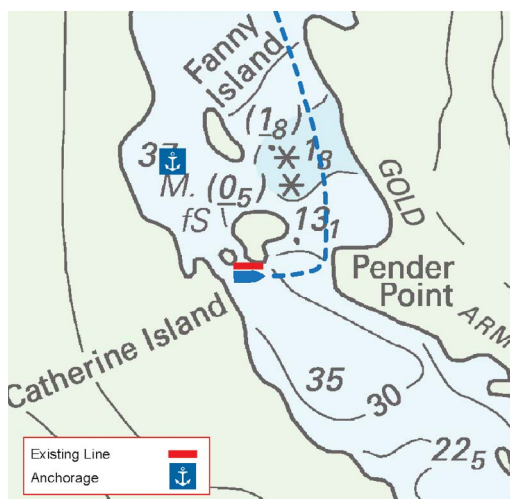

Catherine Island, Gold Arm.

Helipad Anchorage

This is an all-weather anchorage. Tie to the stern lines provided, as this will provide shelter even in bad conditions.

The helipad must not be used as a mooring under any conditions.

Water is available.

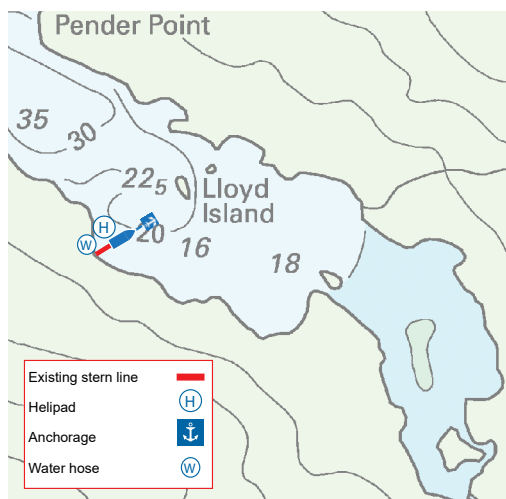

Helipad Anchorage.

Marine Protected Area

Kahukura (Charles Sound) Marine Reserve

This reserve provides a very sheltered habitat away from the influence of ocean swells. It encompasses the inner fiord reaches of Gold Arm, including estuarine habitat, broken rocky reef, rock-wall, and terraced rock-wall habitat.

Spectacular red and black corals are abundant, and on bright days with clear water these can even be viewed from a boat.

The northern half of the marine reserve is a designated area for commercial rock lobster holding and temporary pot storage.



Jason's nudibranch. Photo: Jonathan Davies

Hinenui/Nancy Sound

This is another fiord named by the sealer John Grono, this time after one of his vessels, the *Nancy*. It is known to Māori as Hinenui.

The fiord is 15.4 kilometres long and probably the next steepest fiord after Piopiotahi/Milford Sound. The fiord is shaped very much like a leg, hence the many placenames – Foot Arm, Toe Cove, and Heel Cove.

The mouth of this fiord is perched on the edge of the continental shelf; as a result, there is only a small sand sill.

The entrance to the fiord is narrow because of the nugget-like rocks across the entrance.

Anxiety Island and Entrance Island at the entrance to the fiord have colonies of kekeno/New Zealand fur seals and are also home to the Fiordland skink.

Navigation

When entering Hinenui/Nancy Sound from the northern side, give the sunken rocks shown on LINZ Chart 7624 a wide berth, especially in heavy sea conditions. When travelling from Hinenui/Nancy Sound to Te Awa-o-Tū/Thompson Sound, keep in water deeper than 40 metres.

Anchorage

Toe Cove

This is an all-weather anchorage. During strong winds and sea conditions; however, it may become uncomfortable, and it is recommended that Taiporoporo/Charles Sound or Te Awa-o-Tū/Thompson Sound anchorages should be used.

Radio communication is available on Channel 66.

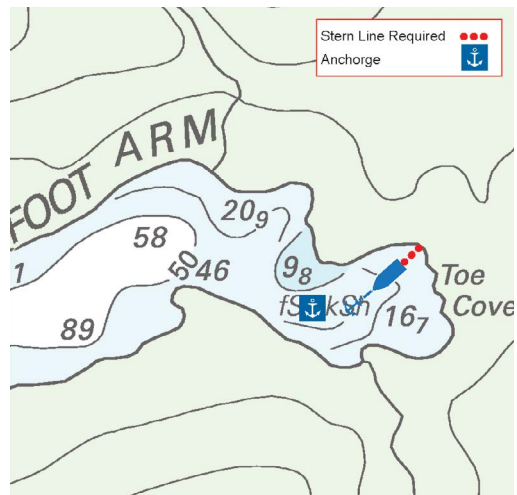

Toe Cove.

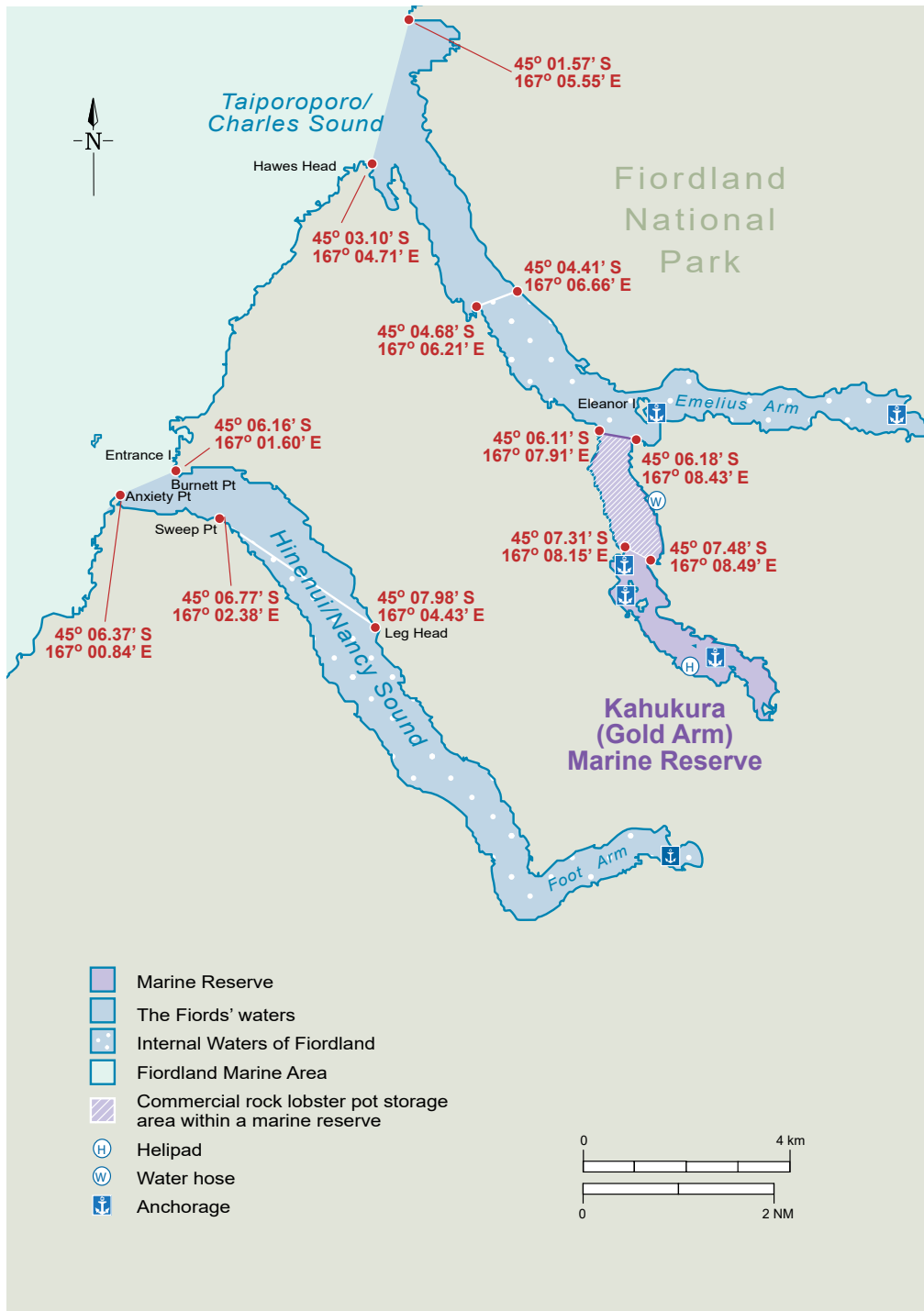

Hinenui/Nancy Sound.

Patea/Doubtful Sound fiord complex

The Patea/Doubtful Sound fiord complex is made up of Te Awa-o-Tū/Thompson Sound, Kaikiekie/Bradshaw Sound, and the main reach of Patea/Doubtful Sound, which has three distinct arms – First Arm, Crooked Arm, and Hall Arm.

Patea/Doubtful Sound, at 40.4 kilometres, is the second longest fiord after Tamatea/Dusky Sound, and at 443 metres, the deepest. Several arms split off the main reach of the fiord creating a complex system that is fed by some large rivers.

The Māori name for Doubtful Sound, Patea, means 'the sound of silence'.

On his first voyage to Fiordland in 1770, Captain James Cook named this fiord 'Doubtful Harbour', doubting the ability for ships to safely sail out of the fiord without an easterly wind.

In 1891, the first groups of hardy trampers began traversing the 18-kilometre walking track over the Wilmot Pass from West Arm to Deep Cove. The opening of the Wilmot Pass road in 1965 (as part of the Manapouri tailrace hydro scheme) further increased tourism visitor numbers. Patea/Doubtful Sound is now the second most visited fiord in Fiordland.

This fiord complex has three marine reserves and other management measures to protect the special marine life that inhabits this waterway.

Huts

There are two Department of Conservation huts in the Patea/Doubtful Sound and Te Awa-o-Tū/Thompson Sound complex:

- the Deas Cove hut, which sleeps 10 people
- the Gut hut, which sleeps six. Note that this hut is situated on Secretary Island, which has never had rats or mice present.



Please be aware of your biosecurity when going ashore on Kā Tū-waewae-o-Tū/Secretary Island.

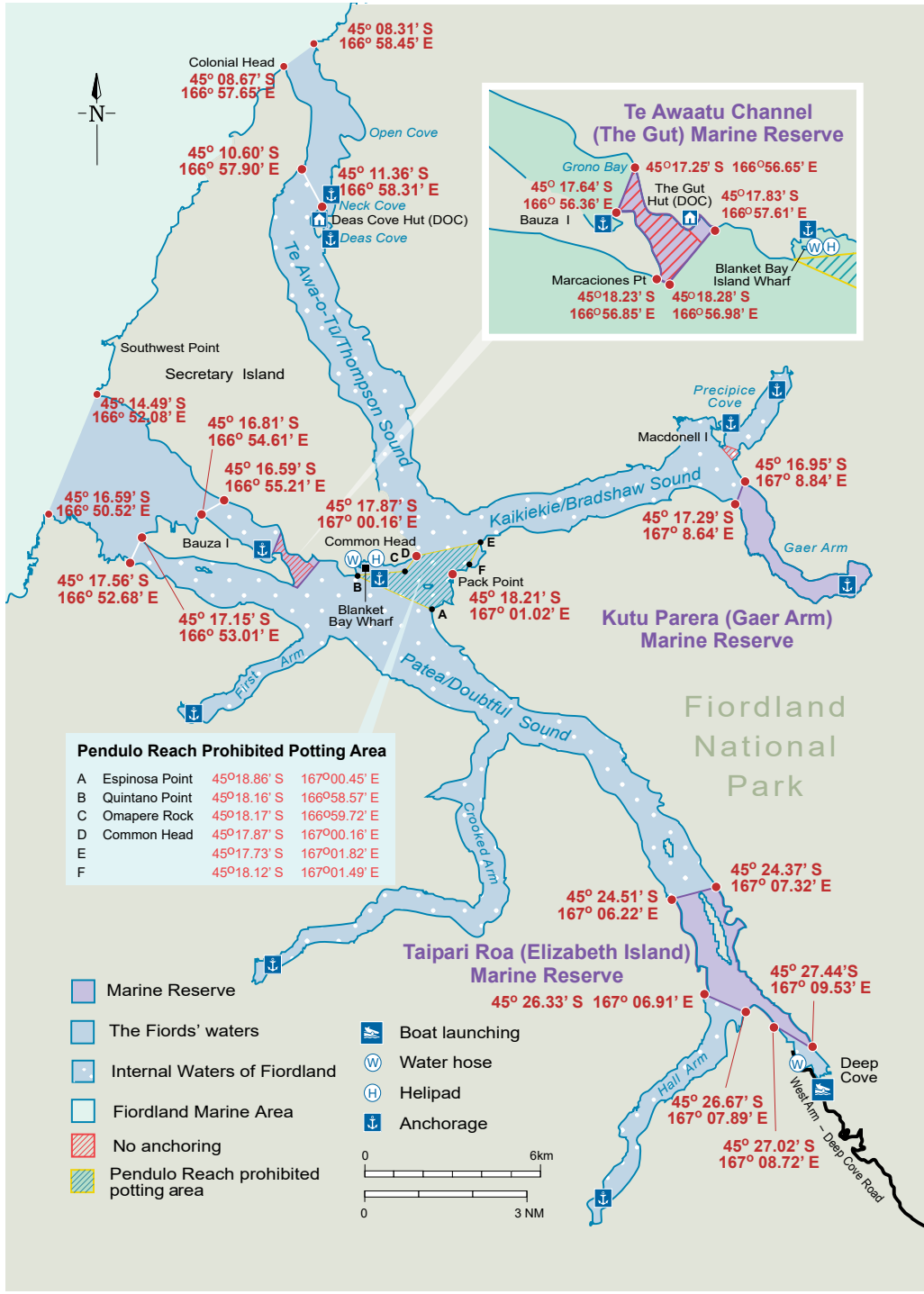

Patea/Doubtful Sound fiord complex.

Resident bottlenose dolphin population

The Patea/Doubtful Sound fiord complex is home to a population of bottlenose dolphins. It is one of the southernmost resident populations of this species in the world. The population here is morphologically (ie, in form), socially, and ecologically different from other groups of bottlenose dolphins. They are much bigger than other bottlenose dolphins, reaching up to 4 metres long, and have smaller fins, presumably to conserve body heat in a colder environment.

Monitoring starting in the early 1990s detected a population decline of at least a third by the late 2000s, due mostly to high rates of calf mortality. In recent years the population has grown, but they are still a small population, and considered critically endangered by the International Union for Conservation of Nature, so still need our care and vigilance.

Protection measures have been in place since 2008. These include:

- guidelines for how vessels operate in Patea/Doubtful Sound
- education and public awareness.

These measures aim to minimise the potential impacts of vessels on the dolphins by reducing the number and duration of interactions between them and boats. These measures are in addition to the Marine Mammal Protection Regulations 1992, and have been adopted by all of the resident commercial users. **Recreational boaties are also encouraged to adopt them.**

Dolphin Protection Zones have been put in place in some parts of the Patea/Doubtful Sound complex. These consist of 200-metre-wide strips along the fiord edge that have restricted access for vessels. These areas have been identified as high-use areas for the dolphins, so limiting boat time here gives the pod an area free of disturbance (see **map**, opposite).

Guidelines for use of the dolphin protection zones are:

- do not enter the dolphin protection zones if dolphins are present
- if dolphins are not present you can enter these zones to access fishing and diving spots, anchorages, and shore features, using the **most direct** route in and out. If dolphins approach while you are in a dolphin protection zone and you are stationary, please let them pass before moving off. If you are already moving, stay on the same heading, where it is safe to do so
- speed in the dolphin protection zones must be 5 knots or idle (as required by Navigation Safety Bylaws 2003).

In the rest of the Patea/Doubtful Sound complex, dolphin encounters must be left to chance or be initiated by dolphins; that is, vessels should not seek out the dolphins. Please do not use your radio to tell others where the dolphins are located. Extra caution should be taken between December and March, when there are very young calves in the group, as these individuals are the most susceptible to disturbance.



Bottlenose dolphins. Photo: Chloe Corne, DOC

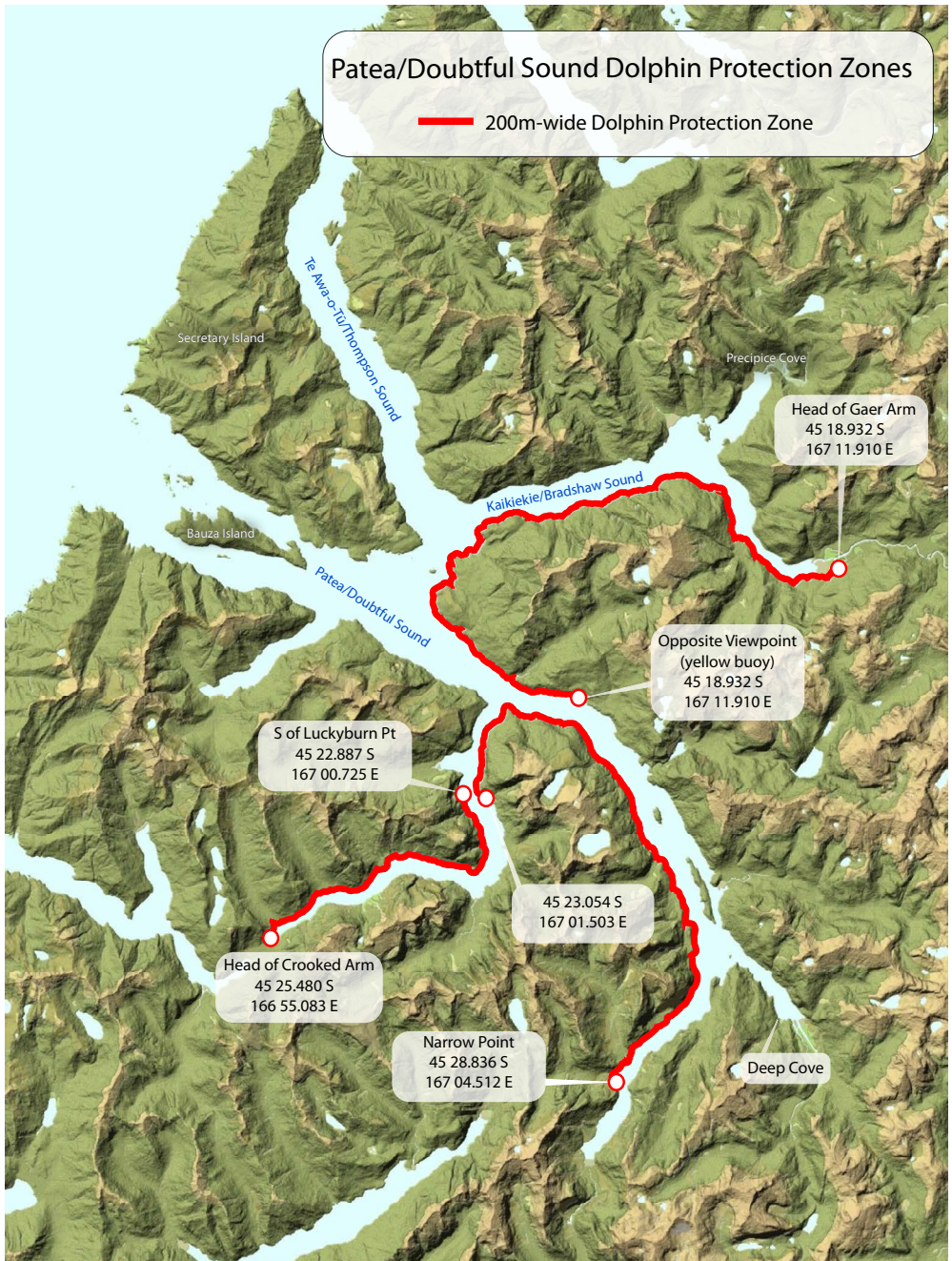

Patea/Doubtful Sound dolphin protection zones.

Te Awa-o-Tū/Thompson Sound

See **map**, page 101.

The Māori name for Thompson Sound, the northern arm of the complex, is Te Awa-o-Tū, and references the Māori creation story of the atua, Tū-te-rakiwhanoa.

Sealer John Grono is responsible for the name, Thompson Sound, after Andrew Thompson, the owner of Grono's vessel the *Governor Bligh*.

Kā Tū-waewae-o-Tū/Secretary Island is the 1,198-metre high, 8,100 hectare island at the seaward end of Patea/Doubtful Sound (splitting Patea/Doubtful Sound and Te Awa-o-Tū/Thompson Sound).

Since 2005 the Department of Conservation has had an ambitious project to remove stoats and deer from the island, to restore it to its pre-European days. At the time of publication there are only a handful of stoats left on the island, no rats, no mice, and no deer. The island has a unique invertebrate community and is home to many rare or endangered native birds.

See '**Biosecurity**', page 16, for more information.



It is very important that when your vessel is anywhere near Kā Tū-waewae-o-Tū/Secretary Island you are aware of your biosecurity responsibilities.

Anchorage

Neck Cove

This is a good anchorage for south-easterly winds. Keep to the north-eastern side when entering the cove to avoid the rocks on the south-western side of the bay, which are covered at high tide.

Radio communication is available on Channels 66 and 61 with a good aerial.

Deas Cove

In strong northerly and westerly conditions, gusts of wind will come from the western shore. This is not a suitable anchorage in south-easterly conditions. There is a line coming from the shore, which is attached to a mooring in the water on the eastern side. Tie to the attached floating line. Not good for anchoring; no holding.



Anchorage in Te Awa-o-Tū/Thompson Sound.

Kaikiekie/Bradshaw Sound

See **map**, page 101.

Kaikiekie/Bradshaw Sound was named by Captain Stokes after R Bradshaw, who was the mate on the *Acheron*. Kaikiekie translates to ‘eat kiekie’, a thick native vine, its fruit considered a delicacy by Māori.

Anchorage

Head of Precipice Cove

This is an all-weather anchorage. There are several moorings here, including a mooring for RealNZ at the head of the cove that is used for overnight cruises, and several other moorings for charter boats.

Radio communication is available on Channel 66.

Macdonell Island, Precipice Cove

This is an all-weather anchorage. Tie alongside the line provided. However, with more than two vessels, use the line as a stern line as shown on the map.

Radio communication is available on Channels 66 and 61 with a good aerial.

Gaer Arm

This is a good moderate-weather anchorage and is probably one of the most scenic anchorages in all the fiords. It is situated next to Camelot River and has stunning views. Be aware of submerged/sunken trees by the mouth of the Camelot River.

The Camelot River in Kaikiekie/Bradshaw Sound can be negotiated by dinghy. It’s possible to navigate about 4 kilometres up river at high water.

Radio communication is available on Channels 66 and 61.

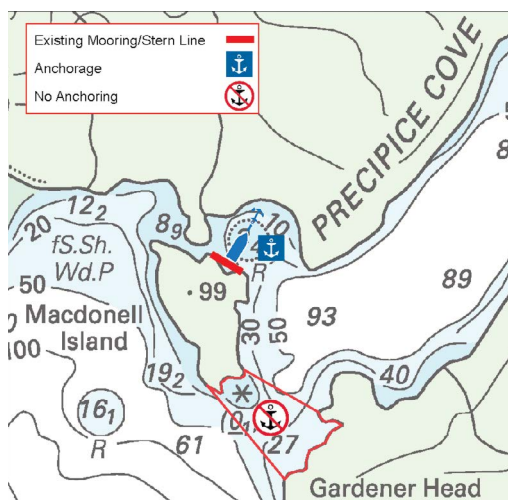

Macdonell Island, Precipice Cove.

Marine Protected Areas

Kutu Parera (Gaer Arm) Marine Reserve

This reserve includes a large estuary at the entrance of the Camelot River. The eastern side of the reserve contains extensive rock-wall habitats, with some vertical drops of 60 metres. These rock walls are home to many anemones and other colourful sessile suspension feeders.

The western side of Gaer Arm has more broken rocky-reef habitats, with underwater boulders and one large river outflow. Seagrass, cockle and pipi beds in the estuarine habitats of the Camelot River are among the largest populations of these species found in Patea/ Doubtful Sound. The sediment fans have significant beds of these bivalves, which are a common source of food for fish such as groper and tarakihi.

Precipice Cove china shop – no-anchoring area

This china shop area from Macdonell Island to Gardener Head is associated with the sill at the entrance to Precipice Cove in Kaikiekie/ Bradshaw Sound. This sill creates a fiord within a fiord (see **map**, page 101). The diverse wall community associated with the sill is of special significance.



Crinoid/Featherstar. Photo: Steve Wing

Patea/Doubtful Sound

See **map**, page 101.

Access to Patea/Doubtful Sound other than by boat is via Lake Manapouri and over the Wilmot Pass. Vehicles travelling across the Wilmot Pass are required to obtain a permit from the Department of Conservation in advance, or there are concession operators who can tow boats across the pass. Several commercial passenger boats operate out of Deep Cove, and trailer boats can be launched from the foreshore. The Deep Cove Hostel Trust runs an education programme catering for more than 1,000 school children each year, and offers accommodation.

Navigation

Care is needed, especially by small craft, near the outlet for the Manapouri Power Scheme freshwater discharge. In this area around Deep Cove, the current may vary at any time.

Te Awa-o-Tū/Thompson Sound to Patea/Doubtful Sound – when steaming (moving) on the outer coast there is an area of shallow water between South West Point and Rocky Point off the coast of Secretary Island. In rough weather it is advisable to stay 2 nautical miles offshore, as large breaking waves will break a long way from the coast.

When travelling from Patea/Doubtful Sound to Te Rā/Dagg Sound, keep in water deeper than 40 metres.

Anchorage

Outside the Gut hut

A **no-anchoring area** encompasses most of the Te Awaatu Channel Marine Reserve. Outside the Gut hut, however, there is an area for anchoring small boats, but it is only suitable in easterly and light south-westerly conditions, and most definitely not a good anchorage for larger vessels.

Please be aware of your biosecurity responsibilities when mooring here or using the hut on Secretary Island. Please check dinghies, kayaks and bags for rodents.



The Gut.

Deep Cove

Contact the Deep Cove Hostel before berthing, to find out the best place to anchor/moor. Petrol, diesel and water are available here from the hostel manager, with either credit card or internet banking. It may be possible to discharge sewage into the sewage treatment facility.

To enquire, contact RealNZ (via *Patea Explorer* or *Fiordland Navigator* skipper) once in the waterway of the Patea/Doubtful Sound complex (best done on Channel 10).

When heading into Deep Cove, VHF Channel 10 should be used. Usually, it is only possible to get radio communications with the Deep Cove Hostel (Channel 10) east of Elizabeth Island. Channel 61 is available here.

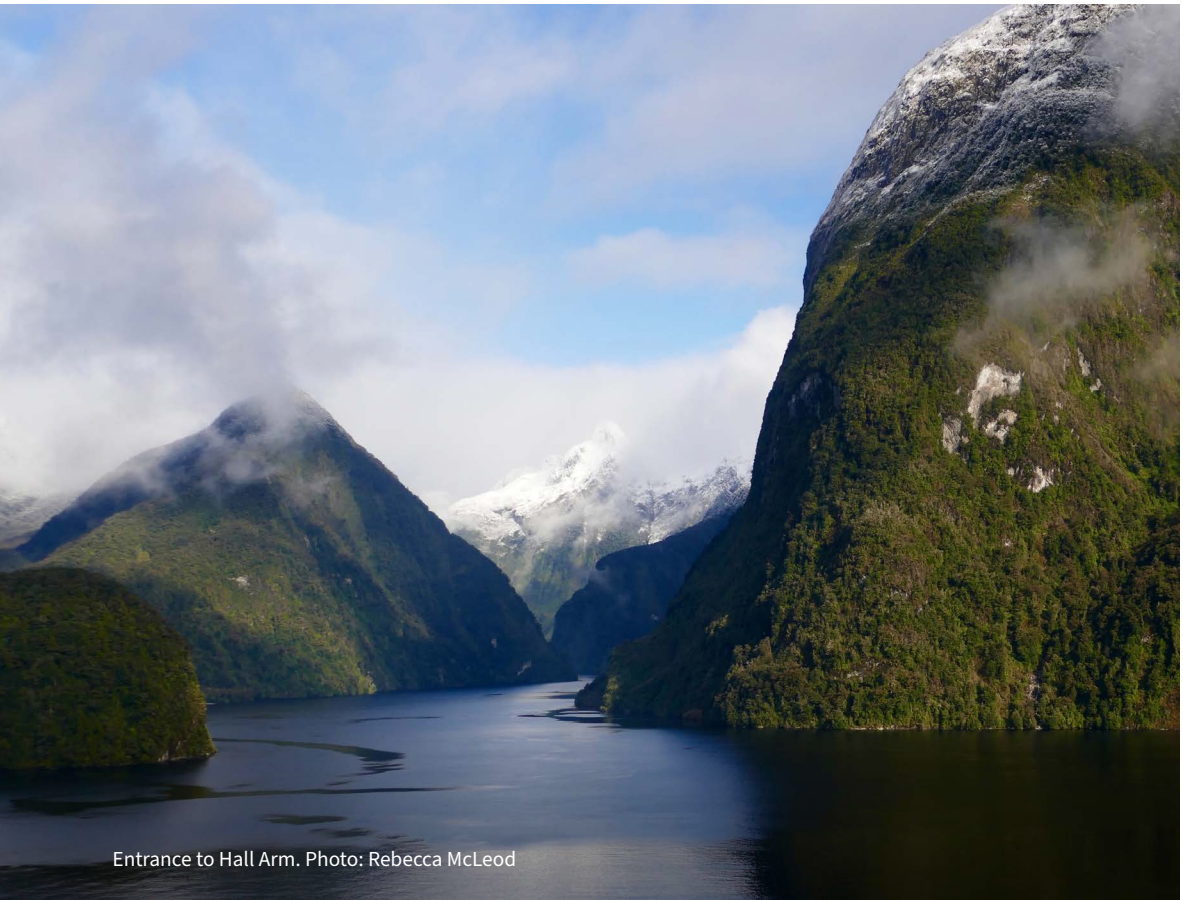

Entrance to Hall Arm. Photo: Rebecca McLeod

Snug Cove, First Arm

This is a good fair-weather anchorage at the head of the arm. It is not suitable in fresh to strong northerly conditions. Keep to the middle of the fiord to avoid the shallow areas on either side of the anchorage.

Care should be taken to avoid anchoring within a 150-metre radius of the large yellow mooring situated at the entrance to Snug Cove due to underwater hazards associated with this mooring.

Radio communication is available on Channels 66 and 61.

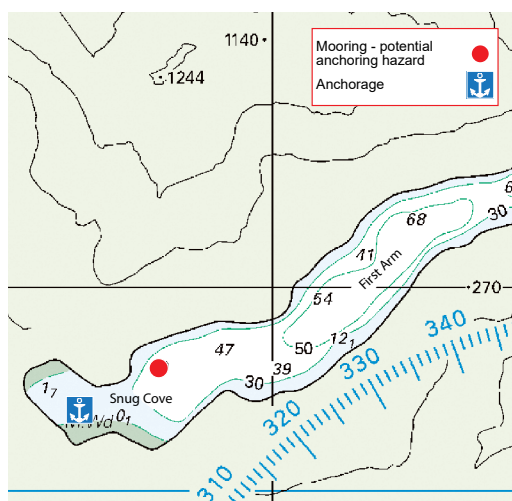

Snug Cove, First Arm.

Haulshore Cove, Crooked Arm

This is a reasonable fair-weather anchorage, but beware as it is shallow and tidal. From the head of Crooked Arm a track leads to Te Rā/Dagg Sound (50-minute walk), signposted with a large orange triangle at the start of the track.

Note that there are no radio repeater communications from here.

Blanket Bay, Kā Tū-waewae-o-Tū/ Secretary Island

This is a good anchorage in westerly conditions but is not suitable for strong north-easterly and south-easterly conditions. Note that there is a sunken rock, as shown on the map. Use the stern line or the mooring as shown on the map. There is a water hose available at the wharf on Blanket Bay Island, off Secretary Island. Leave ropes and the water hose as you found them. The wharf should not be used for berthage. This is a privately-owned facility so please treat it with respect.

Secretary Island is a largely predator-free island. See 'Island biosecurity', page 25. Please take care when travelling on and around this island and check all dinghies, kayaks and bags for rodents if you are going ashore.

Radio communication is available on Channels 66 and 61.

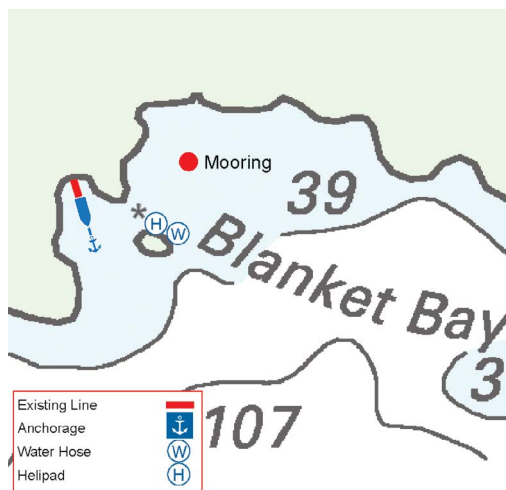

Blanket Bay, Kā Tū-waewae-o-Tū/ Secretary Island.

Marine Protected Areas

Te Awaatu Channel (The Gut) Marine Reserve

Te Awaatu or Te Awa-O-Tū is ‘the channel of Tū’, referring to the Māori ancestor and atua, Tū Te Rakiwhānoa, who carved out the fiords with his magical adze, Te Hamo.

The reserve is much shallower than the surrounding deep-water basin habitats, which are the deepest in Fiordland, reaching depths of 443 metres. There are significant rock-wall and deep-reef habitats, and the reserve is known for sea pens and other suspension feeders, including red and black corals, zoanthids, and brachiopods (lampshells). Observing sea pens involves diving to more than 30-metre depth, so caution is required.

The unique nature of the ecosystem at The Gut, combined with the marine reserve protection that has been in place since 1993, means that many species are found here in greater numbers and sizes than in other areas of the Patea/Doubtful Sound complex, which illustrates why marine reserves are so valuable.

Note: no-anchoring area here (see [page 107](#)).

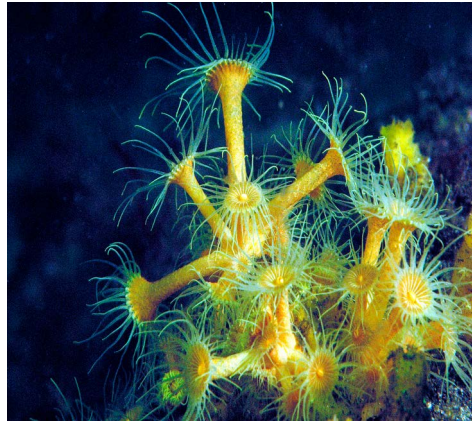

Yellow zoanthid. Photo: Steve Wing



Jock Stewart and sea pens. Photo: SeacologyNZ.com / Irene and Crispin Middleton

Pendulo Reach china shop

Pendulo Reach is a special place, home to many species that are fragile. The area is relatively shallow (in some places less than 50 metres deep) as it is an old glacial sill, and underwater currents moving across the sill make it a perfect place for corals, sponges and other species to inhabit.

Pendulo Reach was designated as a china shop in 2011. Protection measures are in place to prevent damage to this sensitive and fragile biodiversity-rich area.

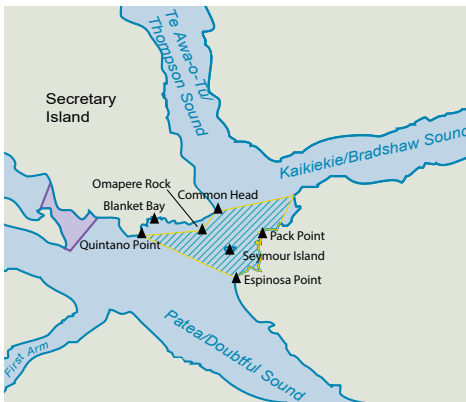

Pendulo Reach (Patea/Doubtful Sound) pot prohibition area (striped area). MPI

It is **prohibited to use rock lobster pots and holding pots** within the Internal Waters area of Pendulo Reach (the passage and waters around Seymour Island).

Large vessels including cruise ships are **not allowed to anchor** in Pendulo Reach.

Taipari Roa (Elizabeth Island) Marine Reserve

This reserve contains extensive rock-wall habitats on the western side of Elizabeth Island and deep kelp beds on the southern end of the island.

In the channel between Elizabeth Island and the eastern side of the fiord there is a relatively shallow channel that experiences high water flow and contains suspension feeders including black and red coral and zoanthids. The reserve is home to a unique assembly of bright yellow glass sponges that are only known to occur in one other place worldwide, in caves in Jamaica.

Monitoring of the area since the construction of the Manapouri hydroelectric power scheme suggests there have been some major changes in marine communities in Patea/Doubtful Sound as a result, including effects on black corals around Elizabeth Island

Te Rā/Dagg Sound

Te Rā/Dagg Sound is named after Captain William Dagg of the *Scorpion*, who collected over 4,500 seal skins from the area in 1804. Its Māori name, Te Rā, means 'the sun'.

Te Rā/Dagg Sound is a narrow, long fiord (13.3 kilometres). The head of the fiord ends only 1 kilometre across land from the head of Crooked Arm in Patea/Doubtful Sound (there is a 50-minute track walk between the two arms). Te Rā/Dagg Sound has one prominent arm to the north called Anchorage Arm.

Wonderful underwater scenery and marine growth make for good diving in Te Rā/Dagg Sound. The outside of the fiord entrance is also known for the presence of whales, which are regularly seen off the northern entrance to the fiord. This is due to the close proximity of the continental shelf where water drops away to thousands of metres deep.

Navigation

There is a shallow rock on the northern side of the fiord halfway between the entrance and Otago Point (see LINZ Chart 7624) that will break regularly.

When travelling from Te Rā/Dagg Sound to Te Puaitaha/Breaksea Sound, keep in water deeper than 45 metres.

Be careful of the shallow area at the entrance to Te Puaitaha/Breaksea Sound south of Rocky Point (see LINZ Chart 7653 marked 64). In a heavy northwest roll this area will break.

Anchorage

In poor weather it is best to avoid Dagg Sound as it is difficult to find a good anchorage.

Anchorage Cove

This is a reasonable moderate-weather anchorage at the head of the cove, which is not suitable in strong southerly conditions.

Channel 61 available.

Head of Te Rā/Dagg Sound

This is a fair-weather anchorage only. Drop anchor in 10 to 15 metres.

Radio communication is available on Channels 66 and 61.

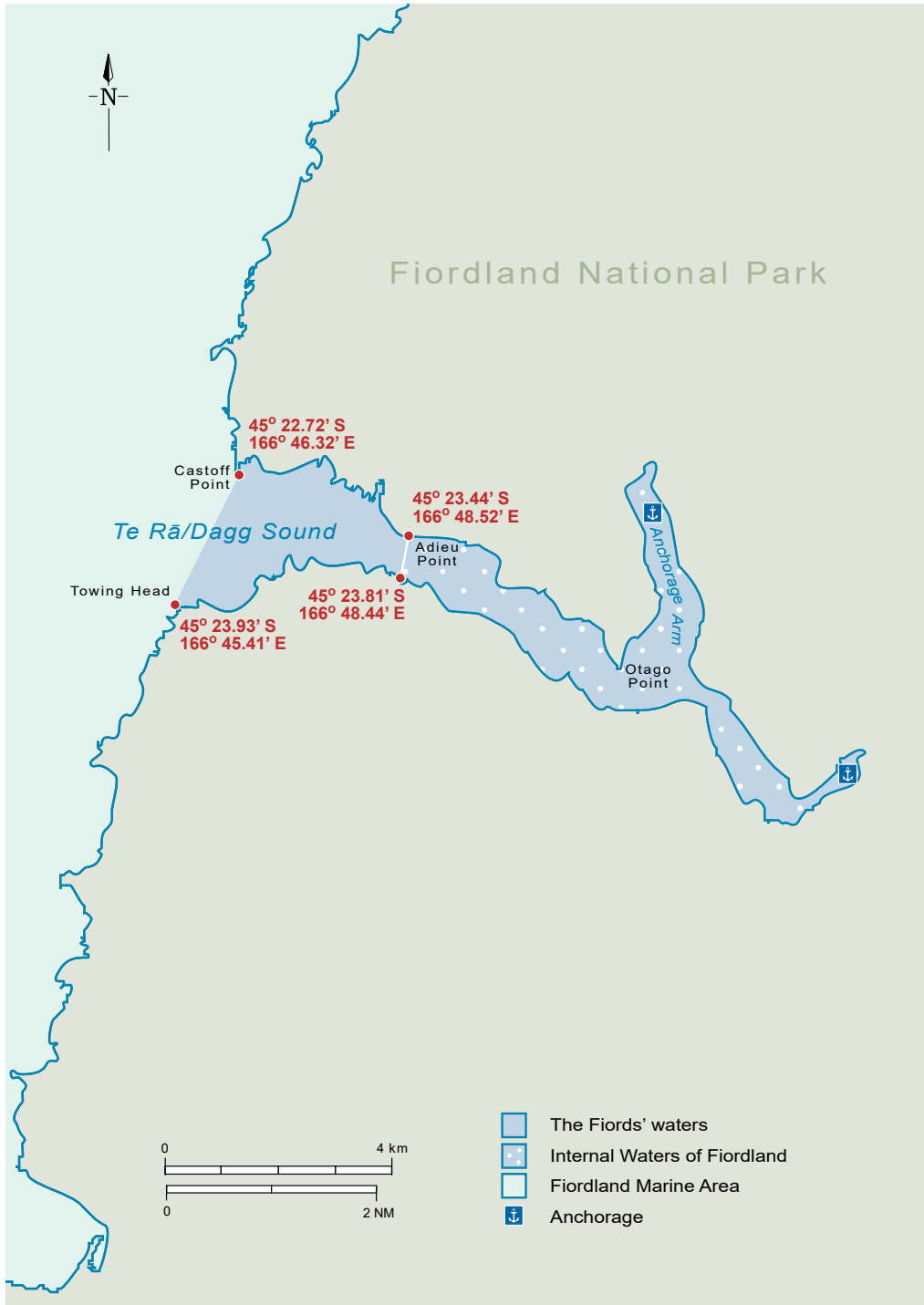

Te Rā/Dagg Sound.

Te Puaitaha/Breaksea Sound and Tamatea/Dusky Sound complex

Like the Patea/Doubtful Sound complex, the Te Puaitaha/Breaksea Sound and Tamatea/Dusky Sound complex is a combination of interconnected fiords – Te Puaitaha/Breaksea Sound, Moana Uta/Wet Jacket Arm, the Acheron Passage, and Tamatea/Dusky Sound.

Tamatea/Dusky Sound is the biggest fiord complex in Fiordland, covering almost 30,000 hectares.

There is a population of bottlenose dolphins here that is believed to be resident, or ‘philopatric’, meaning they prefer to stay within this greater fiord complex. Please be aware of your responsibilities around marine mammals when travelling in the area.

There are also several islands here that are internationally important for conservation. Pukenui/Anchor Island, Ka Huru-huru-o-koekoea/Breaksea Island, and Hāwea Island are predator-free and home to several endangered native species, including the critically endangered kākāpō (flightless parrots) on Pukenui/Anchor Island. Most of the other major islands in this archipelago are predator-controlled (see **map**, page 27).

Mauīkatau/Resolution Island, which is Fiordland’s biggest island (20,860 hectares), is one of the Department of Conservation’s most ambitious projects for stoat eradication. It was the first area in Aotearoa to be set aside as a reserve (in 1891), and was managed by caretaker Richard Henry. Henry had observed the damage introduced predators were having on native bird species and transferred kākāpō and kiwi to Resolution Island and other smaller islands, in the hope of protecting the birds. The remains of Henry’s camp are still visible today on Pigeon Island, to the west of Resolution Island.

Resolution Island and all the other small islands in Tamatea/Dusky Sound are unique for the low level of pests and predators. It is absolutely crucial when travelling in the vicinity that you are aware of your biosecurity responsibilities. See ‘**Biosecurity**’, page 16.



Te Puaitaha/Breaksea Sound and Tamatea/Dusky Sound.

Undaria in Te Puaitaha/Breaksea Sound and Tamatea/Dusky Sound complex

The Asian seaweed *Undaria* was originally discovered in Sunday Cove, Te Puaitaha/Breaksea Sound in 2010. Despite an enormous effort to control it, *Undaria* is now found outside the *Undaria* exemption area in Te Puaitaha/Breaksea Sound, the Acheron Passage, and along the Bowen Channel in Tamatea/Dusky Sound (see map opposite). The Guardians and management agencies are determined to contain it within this fiord complex and work is ongoing to reduce its biomass.

- Vessels, anchors and other marine gear must be free of *Undaria* when they leave the Te Puaitaha/Breaksea Sound exemption area (see map).
- Throughout the fiord complex, please ensure your hull and gear is clean and well maintained See '**Keeping marine pests out of Fiordland**', page 22.

- Please do not remove shellfish from or move fishing gear such as pots out of the Te Puaitaha/Breaksea Sound and Duck Cove and Fixed Head, Tamatea/Dusky Sound areas as they may be infected with *Undaria* spores and could spread *Undaria* to other areas.
- Please refrain from setting cray pots in the *Undaria* exemption area.
- Ensure any marine equipment used, especially dive (eg, wetsuits) and fishing gear, is clean and dry, or treated after every use. If you see *Undaria* beyond these known sites, please take note of the exact location and report it to Environment Southland (0800 76 88 45) as soon as possible.



Undaria. Photo: Louise Bennett-Jones

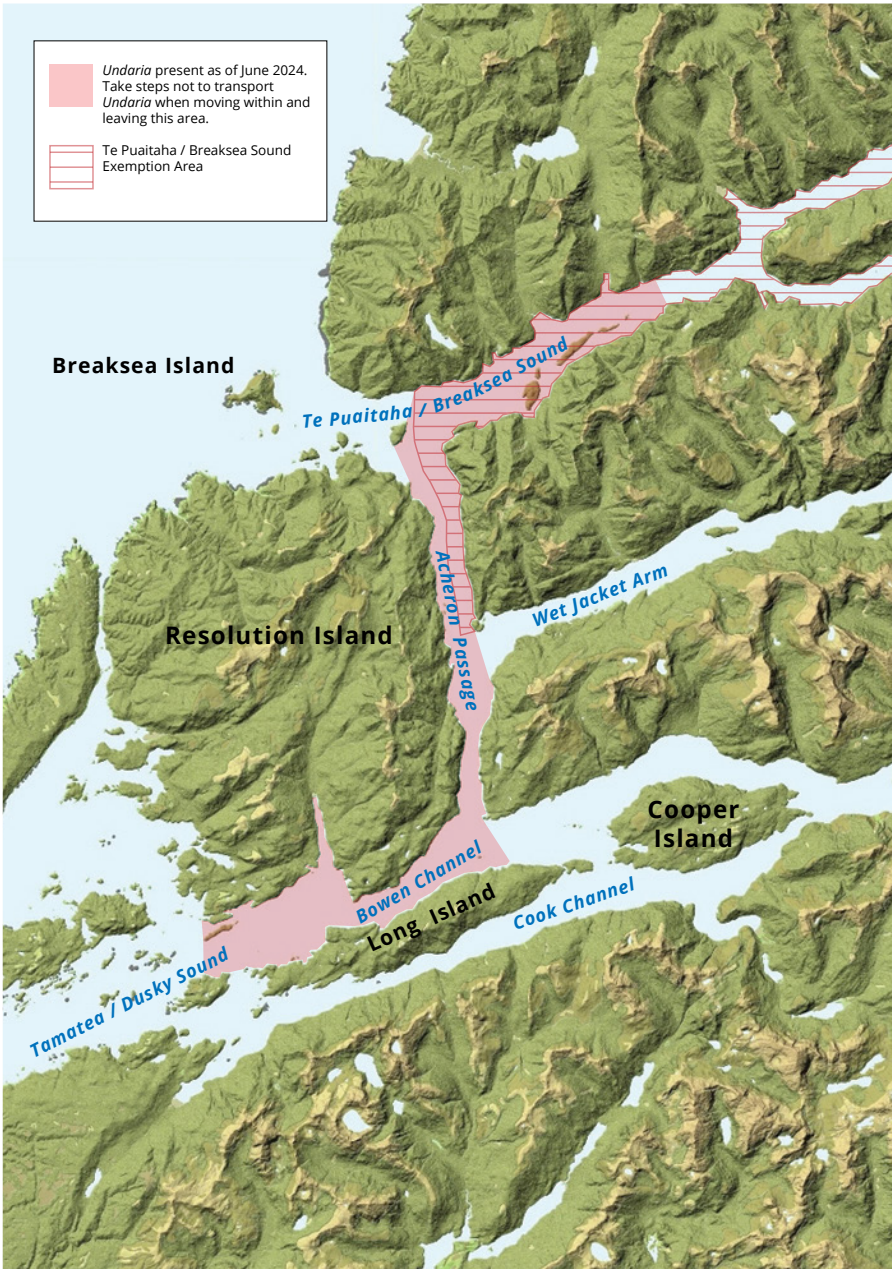

The extent and location of *Undaria* within Te Puaitaha/Breaksea Sound and Tamatea/Dusky Sound, and the Te Puaitaha/Breaksea Sound exemption area. See the Southland Regional Pest Management Plan for more details.

Te Puaitaha/Breaksea Sound

Breaksea Sound, also known as Te Puaitaha, is named after Breaksea Island, which is at the entrance to the fiord. It was named by Captain John Stokes during his survey in HMS *Acheron*.

The northern reaches of the fiord were previously noted by Captain Cook as ‘Nobody knows what’ because he didn’t have time to explore the arms to discover whether the northern arm connected to Patea/Doubtful Sound. In 1791, Captain George Vancouver completed Cook’s previous exploration and named it ‘Somebody knows what’. Vancouver Arm was later named in honour of Vancouver.

Te Puaitaha/Breaksea Sound is 33 kilometres long and splits into two arms at its head (Vancouver Arm and Broughton Arm, the latter also known as Waimaunu), which are similar in appearance to the more northerly fiords. There are many densely forested islands spread throughout the whole of Te Puaitaha/Breaksea Sound, making it another very beautiful corner of Fiordland.

There is good evidence of early Māori visitation in the far reaches of Te Puaitaha/Breaksea Sound, where many rock shelters can be found.

Navigation

Towards the head of Vancouver Arm there is a shallow estuarine sill from a river off the northern side, which must be avoided. Stick to the southern side heading to the top of the arm as the shallow sill comes two-thirds of the way across.



Please ensure your anchor and chain are free of seaweed before moving away from any anchorage in this area.

Breaksea Island – No landing

It is **prohibited to land on Breaksea Island**. Entry is strictly by permit only (Department of Conservation). Breaksea Island was the site of the first and largest (at the time) rat eradication programme in the 1980s and paved the way for larger islands and rodent eradication projects around the world. It is therefore an incredibly important island and home to several threatened bird species.

Anchorage

Undaria has been sighted in several anchorages in Te Puaitaha/Breaksea Sound.

Stevens Cove

This is a fair-weather anchorage with a stern line. It is not suitable in strong south-westerly conditions, or in westerly or northerly conditions. It is also adjacent to Resolution Island so please be **aware of biosecurity** when tied up here as rats and mice can easily walk along lines to shore.

Channel 01 available. Channel 18 (Bluff radio) is also available throughout the complex except in Broughton Arm.

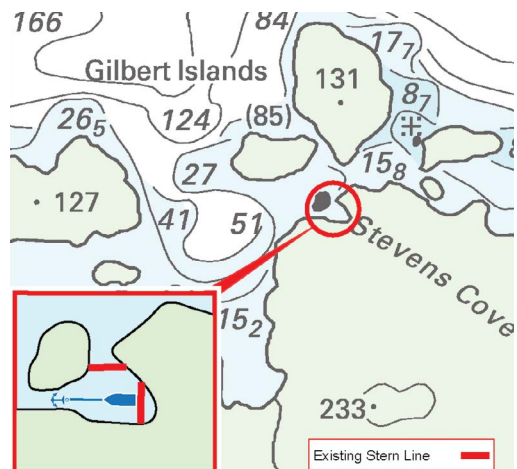

Stevens Cove.

Sunday Cove

This is a good anchorage in most conditions; however, it is unsuitable in very strong conditions from the north and northwest. Ocean roll will be felt in this anchorage. Water is available from the barge.

A barge is moored here and is commonly used to tie alongside. There is also a helipad on the barge that is used to transport lobsters. Caution should be used when manoeuvring in this area. Be aware that helicopters can arrive at any time.

Please do not remove stored fishing gear out of this area, and do not set lobster pots in this area.

Radio communication is available on Channel 01 and 66.

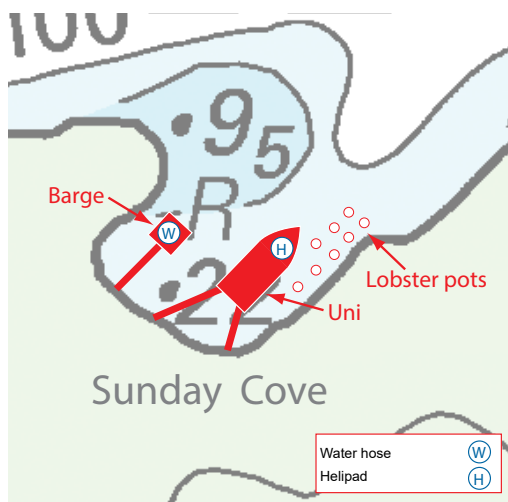

Sunday Cove.

Third Cove

This is a good all-weather anchorage except in very strong northerly winds. Drop anchor at head of cove; a stern line is not required.

Beach Harbour

This is a good all-weather anchorage. In light northerly conditions, anchor in 30 to 35 metres at the bottom of the bank. There are several moorings here that may be available for use on contact with their owners.

Radio repeater communication is available on Channel 01 and 66.

Second Cove

This is a reasonable all-weather anchorage; however, in strong winds use of a stern or breast line is required. Be aware of the rocks on the western side while entering the cove.



Second Cove.

First Cove

Can anchor on western end of the beach in light winds.

The Acheron Passage and Moana Uta/Wet Jacket Arm

The Acheron Passage is named after Captain John Stokes' ship HMS *Acheron*, while Wet Jacket Arm is named after one of Captain Cook's lieutenants, Richard Pickersgill, who was caught here in a fierce downpour. Māori refer to the fiord as Moana Uta, meaning 'the shore of the ocean'.

Acheron Passage is around 15 kilometres long and connects Te Puaitaha/Breaksea Sound in the north to Tamatea/Dusky Sound in the south. The passage is very narrow and is bordered on the western side by Mauīkatāu/Resolution Island.

Moana Uta/Wet Jacket Arm is approximately 20 kilometres long, heading inland from about halfway along the Acheron Passage.



The whole of Moana Uta/Wet Jacket Arm is a marine reserve.

Anchorage

Head of Wet Jacket Arm

This is a good all-weather anchorage.

Muscle Cove

This is an all-weather anchorage. When approaching from the southern side of Stick Island, keep to port as there are rocks on the southwest corner of the island. Use of a stern line is essential.

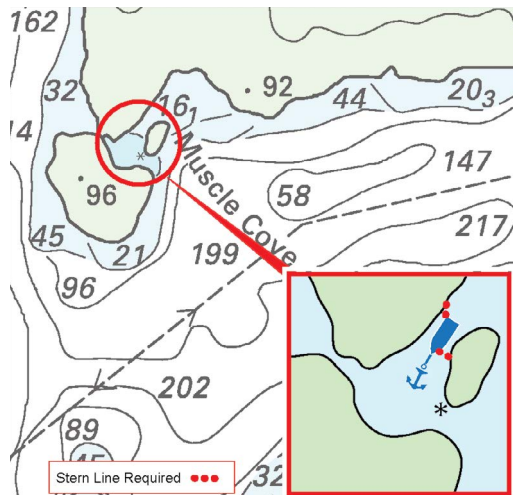

Muscle Cove. Larger vessels may be more secure facing the opposite direction to that pictured.

Oke Island

This is a good fair-weather anchorage between the island and the mainland.

Marine Protected Areas

The Acheron Passage/Wet Jacket Arm china shop – no-anchoring area

At the intersection of the Acheron Passage and Moana Uta/Wet Jacket Arm there is a no-anchoring area, which is shown in red on the fiord map on **page 115**. The pinnacle here contains some large black coral colonies and many very delicate invertebrate species such as lace coral and other bryozoan species that thrive in the high currents. Any anchoring or other disturbance on this pinnacle will break these incredible fragile specimens.

Moana Uta (Wet Jacket Arm) Marine Reserve

This reserve includes significant expanses of rock-wall, broken rocky reef, deep-basin, and estuarine habitats. Sub-tidal rocky reefs in some areas have dense beds of kelp and very low kina populations. Rock walls near Oke Island receive a significant amount of tidal flow and have correspondingly high densities of lampshells (brachiopods) and other suspension feeders. The environment around Moana Uta/Wet Jacket Arm produces the highest known density of black coral of any site in the fiords.



Brachiopod. Photo: SeacologyNZ.com / Irene and Crispin Middleton

Tamatea/Dusky Sound

See also **Te Puaitaha/Breaksea Sound and Tamatea/Dusky Sound map**, page 115.

Tamatea was the name of the legendary Māori navigator and explorer, and captain of the waka, *Takitimu*, who is said to have been the first to find his way here.

Māori inhabited Fiordland for at least a few hundred years before Europeans arrived. Archaeologists suggest Māori habitation may well have been seasonal, in the search for seasonal food, including kaimoana/seafood, land and seabirds and kekeno/fur seals.

The fiord was named Dusky Bay by Captain James Cook on his first visit to Fiordland in 1770, as it was just on dusk and getting dark when he sailed past, the name later changed to Dusky Sound. On Cook's second visit in 1773, on the HMS *Resolution*, he and his crew had six weeks here and made the first, and only, encounters with tangata whenua – on Mamaku/Indian Island, in Cascade Cove and at the head of Tamatea/Dusky Sound, at the mouth of the Seaforth River.

As a result of Cook's detailed charts, sealers and whalers soon followed. Tamatea/Dusky Sound is steeped in history. Aotearoa New Zealand's first European house and wooden ship were constructed at Luncheon Cove on Pukenui/Anchor Island by an 11-man party from the sealing ship *Britannia*, who were dropped off in November 1792 and lived on Anchor Island for 10 months.

There are many wrecks around the fiord, the most famous being the 800-tonne *Endeavour*, which sank off Facile Harbour in 1795, and the tourist steamer *Waikare*, which sank off Stop Island in 1910 during a summer cruise, although today, little remains of either.

Pickersgill Harbour is where Captain Cook moored the *Resolution* for nearly six weeks in 1773. Here, they charted the transit of Venus on what is now named Astronomer Point, the crew made repairs to the

ship, brewed rimu beer, and the scientists aboard catalogued many native species. There is a short walk from Pickersgill Harbour to Astronomer Point.

Tamatea/Dusky Sound is Fiordland's longest, most extensive, and possibly most picturesque fiord, penetrating 43.9 kilometres inland. It is dotted with many islands inside its wide entrance.

Pest-free islands

Pukenui/Anchor Island, in the middle of the fiord's entrance, is home to half the population of endangered kākāpō, along with mōhua/yellowhead, tieke/saddleback, kākāriki/parakeet, kiwi pukupuku/little spotted kiwi, and a host of other native birds and invertebrates. There is an interesting, but challenging walk across Pukenui/Anchor Island, which heads through this predator-free reserve. If you do go ashore, it is imperative to **observe ALL quarantine requirements** before you set foot on, or moor alongside the island. See '**Island biosecurity**', page 25. Camping on Anchor Island is not permitted.

In addition, take care when going ashore on Mauikatau/Resolution Island, Mamaku/Indian Island, and many other small islands throughout Tamatea/Dusky Sound. Check all dinghies, kayaks and bags for unwanted passengers. If not, you could undo decades of predator control, and therefore threaten already critically endangered species.

Navigation

It is very important to have the most up-to-date chart and navigational software, as there are a multitude of rocks and hazards throughout the Te Puaitaha/Breaksea Sound and Tamatea/Dusky Sound complex.

When travelling from Tamatea/Dusky Sound to Taiari/Chalky Inlet, keep in water deeper than 45 metres.

Anchorage

Outer Luncheon Cove

This is a good fair-weather anchorage. Anchor where shown on the map. There are two commercial moorings here, still leaving plenty of room to anchor in 30 metres of water. Take care when travelling in this area as there are numerous small islands and stored pots to navigate around.

Inner Luncheon Cove

This is a good all-weather anchorage and is known for its lack of sandflies. However, it can be very gusty in strong northerly conditions. Use a stern line on the south-eastern shore in conjunction with a breast line that is attached to the stern line, and anchor as shown on the map. Caution should be taken on the approaches to Luncheon Cove because of numerous rocks, most of which are submerged (use the map for guidance).

Please follow biosecurity guidelines – your vessel will be very close to the shore if any rodents are aboard.

Radio communication is available on Channels 01 and 18.

Cormorant Cove

This is a moderate-weather anchorage and should not be used in any fresh to strong northerly conditions.

It is possible to get radio repeater communication here on Channel 01 in good conditions and with a good aerial. Channels 18 and 67 are also available.

Facile Harbour

This is a fair-weather anchorage only (which is one of the reasons the *Endeavour* was wrecked here in 1795, caught in a storm). Caution should be used when entering the harbour as there is a rock on the port-hand side and it is extremely shallow on the starboard side.

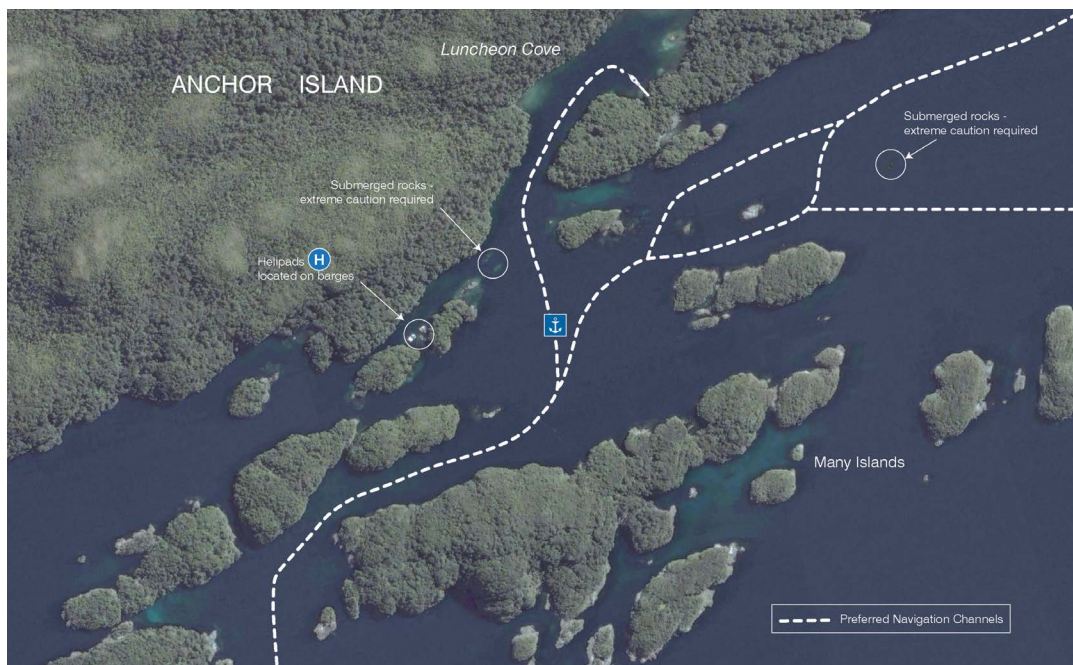

Anchorage areas in Luncheon Cove, Tamatea/Dusky Sound.

Earshell Cove

This is a fair-weather anchorage and the bay should only be entered during daylight hours, through the channel either side of the island at the entrance. It is very narrow but has sufficient depth for safe navigation. There are lots of cray pots stored in here. Not sheltered in northerly conditions.

Radio communication is available on Channels 01, 18 and 67.

Cascade Cove

This is an all-weather anchorage. There is a water hose available to the northeast of the barge attached to a float. Be aware of the marked underwater hazard (as shown on the map) as you enter Cascade Cove, which is associated with a mooring in the middle of this bay. Care should be taken to avoid anchoring within a 100-metre radius of this mooring.

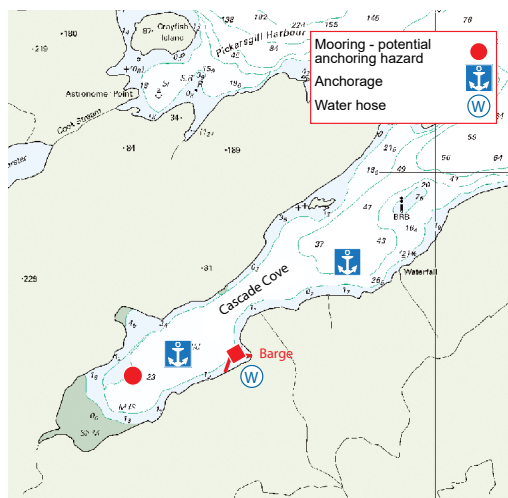

Cascade Cove.

Duck Cove and the Nook

There is a fair-weather anchorage in the middle of Duck Cove. Be aware of the large area of mud flat that protrudes out into the cove. There is a better heavy weather anchorage at the entrance to Duck Cove on the south-western side, as shown on the map. Use of a stern line is essential. There is a water hose halfway along the southern wall of the cove.



Please note that the invasive seaweed *Undaria* is present in and around Duck Cove. Please ensure your hull and anchor chain is clean on departure and do not use or store cray pots in this area.

The entrance to the cove has repeater communication on Channel 01. Channels 18 and 67 are also available.

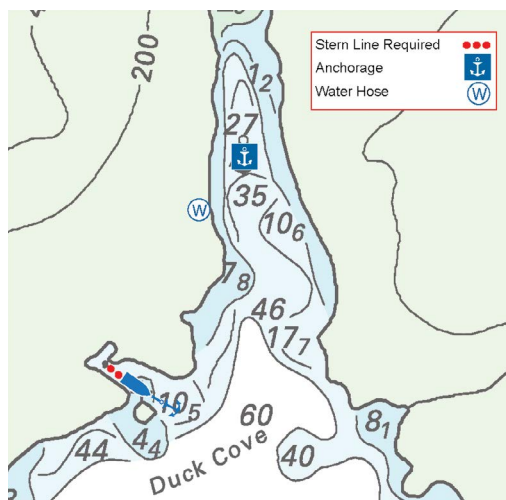

Duck Cove.

Eastern Cooper Island

This is a good south-westerly and westerly anchorage. Use stern line as shown on the map. Please be aware that the vessel *Georgina* is usually moored here, so it is necessary to steer clear from her moorings when anchoring (there is still plenty of room).

Radio communication is available on Channel 18.

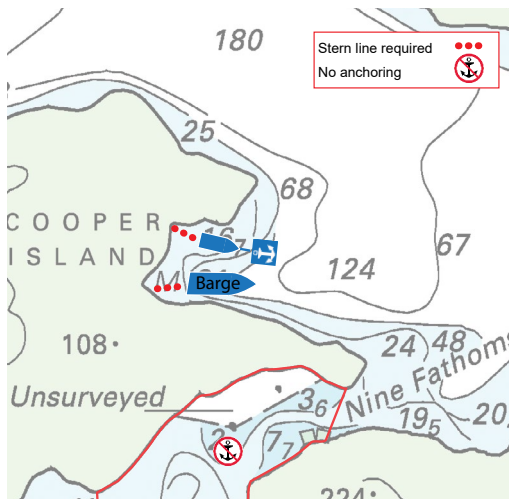

Eastern Cooper Island.

Sportsman Cove

This is a fair-weather anchorage only and should not be used in any strong winds. The entrance is very narrow but is clear of rocks. Anchor in the middle of the cove.

It is possible to receive Channel 01 with a good VHF aerial. Channels 18 and 67 are also available.

Fanny Bay

There is a fair-weather anchorage at the head in around 30 metres of water. No radio repeater communication is available.

Shark Cove

This is a fair-weather anchorage. It is not recommended in strong south-westerly conditions (see Eastern Cooper Island). Anchor in 25 metres of water.

Radio communication is available on Channels 18, 01 and 67.

Supper Cove

This is a fair-weather anchorage and should not be used in strong winds.

Radio communication is available on Channels 18, 01 and 67.

Hut

The head of Tamatea/Dusky Sound, near the Seaforth River, is also the location of the final Department of Conservation hut on the Dusky Track. The hut, which sleeps 12 people, overlooks the fiord at Supper Cove.

Marine Protected Areas

Taumoana (Five Fingers Peninsula) Marine Reserve

Taumoana (Five Fingers Peninsula) Marine Reserve contains some of the only wave-exposed, rocky-reef habitats that are fully protected in the Fiordland marine reserve network. These rocky reefs contain a high diversity of fish and kelp species at a much higher density compared to the inner fiord habitats. The area used to be a major pāua and rock lobster fishery before the reserve was created, and numbers of both are increasing due to protection from harvesting.

Exposure to the southwest means that ocean swells come into Tamatea/Dusky Sound, hitting the southern sides of Parrot and Pigeon Islands, and the eastern side of Taumoana/Five Fingers Peninsula.

The reserve contains shallow habitats and large stretches of estuarine habitats around Taumoana/Five Fingers Peninsula, Cormorant Cove, and Facile Harbour.

A part of the reserve, north of Pigeon Island, is a designated area for commercial rock lobster holding and pot storage.



Rock lobster (kōura). Photo: Malcolm Francis, NIWA

Nine Fathom Passage, Cooper Island china shop – no-anchoring area

Where the passage narrows, high currents foster dense colonies of particularly large bryozoans, black corals and red corals. This is a place of particularly high biodiversity, which is protected from damage by the no-anchoring zone.

See Eastern Cooper Island **map**, page 126 and **map**, page 115.

Taiari/Chalky Inlet

Taiari/Chalky Inlet is one of the most exposed fiords in Fiordland, as it faces to the southwest. It is dominated at the entrance by the striking white cliffs of Chalky Island, which give the fiord its European name. Chalky Island is also known as Te Kākahu-o-Tamatea, meaning 'the cloak of the great Māori explorer chief Tamatea'.

Te Kākahu/Chalky Island and Passage Island are predator free so please be very careful not to introduce pests. Te Kākahu/Chalky Island is also home to kākāpō and several other native bird species and the critically endangered Te Kākahu/Chalky Island skink.

Taiari/Chalky Inlet has a very wide, exposed double seaward entrance of 7 to 8 kilometres, divided by Te Kākahu/Chalky Island, which lies in the middle of the entrance. The expansive fiord stretches 15 kilometres inland until it splits into Moana-whenua-pōuri/Edwardson Sound and Te Korowhakaunu/Cunaris Sound, both of which are roughly 12 kilometres long. Taiari/Chalky Inlet is a substantial body of water of over 60 square kilometres.

The area has a rich Māori and European history. Māori occupied many sea caves and frequented nohoanga/campsites during their seasonal visits to the fiords. European settlers started several short-lived industries in the area, beginning with sealing and whaling, followed in the 1890s by a fish-freezing depot and sawmill.

The exposure to the open ocean creates a lot more outer coast habitat in the fiord, which is dominated by significant quantities of seaweed. The kelp forests in turn support large kina populations, as well as fish and shellfish.

Undaria was found in Northport in Taiari/Chalky Inlet in 2019 but after an eradication programme is once again believed to be *Undaria-free*. See '**Fiordland's *Undaria* Control Programme**', page 20. Although regular surveillance takes place, if you see *Undaria* in Taiari/Chalky Inlet, please take note of the exact location, and report it to Environment Southland by phoning 0800 76 88 45 as soon as possible.

Navigation

It is very important to have the most up-to-date chart for Taiari/Chalky Inlet, as there are a multitude of rocks and hazards throughout, making navigation difficult at times. Best navigated in the flood tide. Be very careful at Providence in ebb tide conditions.

There is a shallow area in Western Passage that can break in heavy swells. The entrance to Taiari/Chalky Inlet can be a dangerous place in large west or southwest swells, so take extra care in these conditions.

When travelling from Taiari/Chalky Inlet to Rakituma/Preservation Inlet, use Broke Adrift passage. This passage is relatively safe unless there is very heavy weather.

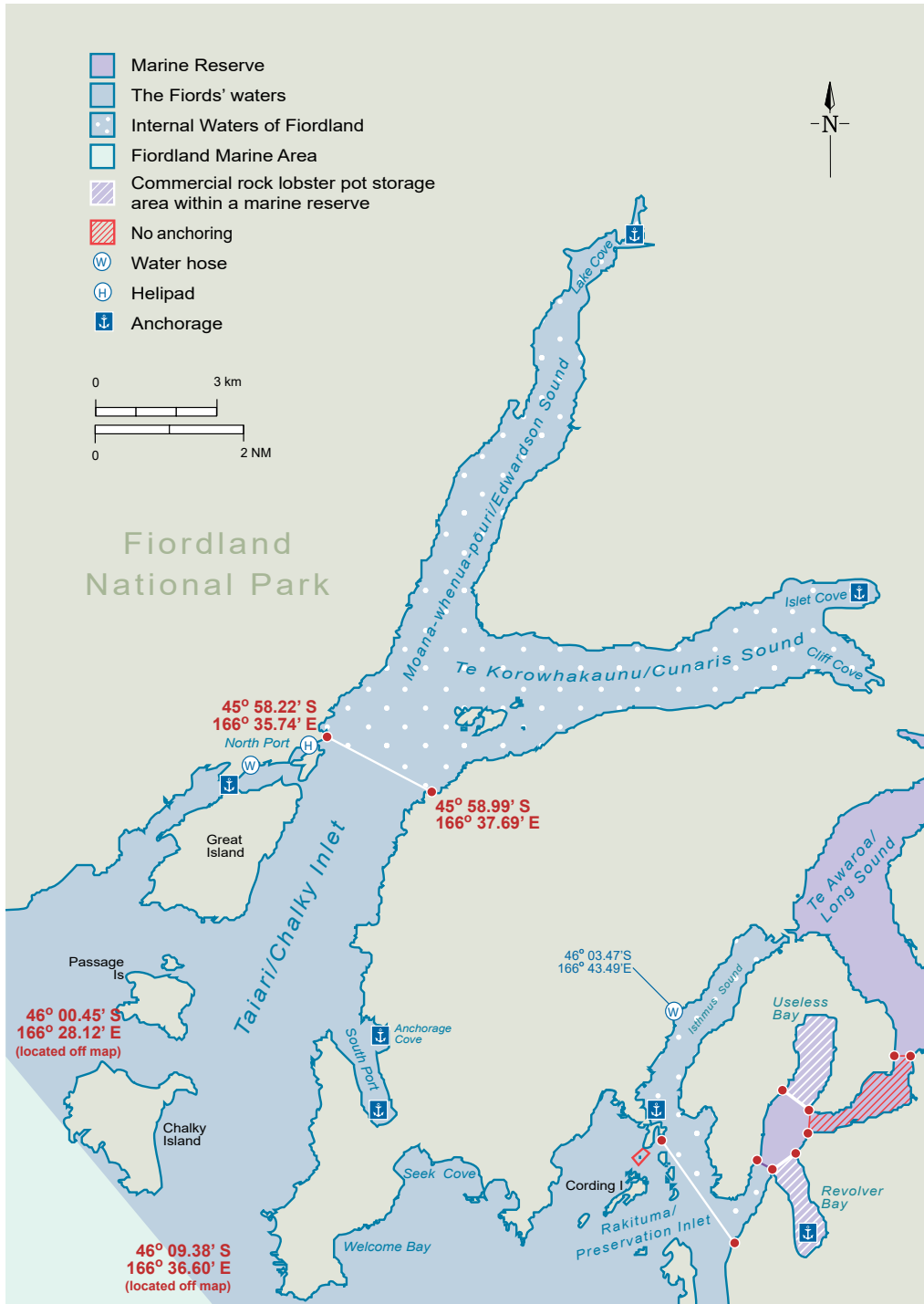

Tairari/Chalky Inlet.

Anchorage

Radio communication is available on Channel 01 for all the anchorages below.

North Port

The two main anchorages in North Port are to be approached only through Ship Entrance, which is between Little Island and Great Island, and not through Blind Passage, which is very shallow. The good all-weather anchorage is on the northern and south-western side of Little Island and can be approached from either side with caution. Anchor and use the stern lines as indicated on the map.

The second anchorage is towards Mosquito Point and is a good anchorage except in strong winds. Water is available from a waterfall in a little bay on the northern side of this anchorage.

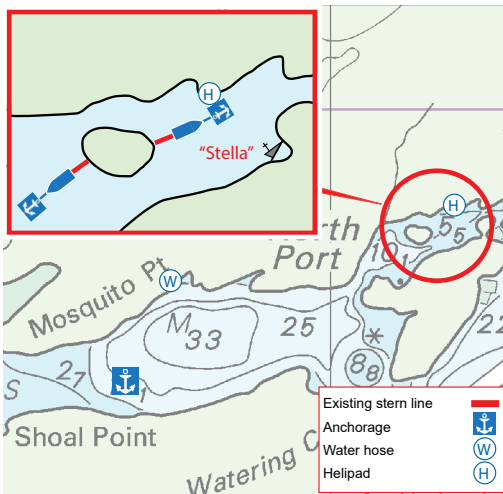

North Port.

Anchorage Cove, South Port

This is a fair-weather anchorage only and is not suitable in north to northwest conditions. Caution should be used when entering South Port as there is a shallow area adjacent to Anchorage Cove (shown on the map).



Anchorage Cove, South Port.

Lake Cove

This is a good all-weather anchorage. Watch for sunken/submerged trees in the mud bank out of Lumaluma Stream.

Islet Cove

This is a fair-weather anchorage.

Rakituma/Preservation Inlet

Rakituma/Preservation Inlet was initially named by Europeans as Preservation Harbour, and then Port Preservation. The Māori name for this area, Rakituma, means ‘the threatening sky’.

Rakituma/Preservation Inlet is the southernmost of the fiords, extending 36 kilometres into the heart of southern Fiordland. It starts off wide and open and contains several islands, coves and small bays. The expansive and aptly named Te Awaroa/Long Sound begins at Narrow Bend and is a marine reserve.

Rakituma/Preservation Inlet has a host of Māori and European historical sites and past industries. The first European settlement here, in 1829, was a shore-based whaling station in Cuttle Cove called ‘Port Bunn’ on land purchased from Māori, with housing for up to 60 people and sheds for 16 whale boats. Less than 20 years later, with the population of whales, particularly Southern right whales, seriously depleted, the settlement was abandoned.

Gold and timber came next, the thriving towns of Cromarty and Te Oneroa established to service the gold miners and to ship out sawn timber. The last gold mine closed in 1913.

Despite the forest reclaiming most of the buildings or structures, there is still plenty of evidence of gold mining, with quartz gold-stamping batteries, various mines, a smelter, sawmills, and bush tramways. What does remain is fragile, so please respect these sensitive historic sites.

There is a stunning, but usually windswept, walk out to the lighthouse on Puysegur Point, where Fiordland’s first lighthouse was built in 1879.



Coal Island is a pest free island, with ongoing work by the Coal Island Trust to control stoats. Biosecurity rules apply. Please be vigilant and check all dinghies, kayaks and bags for unwanted passengers before going ashore.

Navigation

As with Taiari/Chalky Inlet, it is very important to have the most up-to-date chart or electronic software for Rakituma/Preservation Inlet, as there are a multitude of rocks and hazards throughout, making navigation difficult at times. Best navigated in flood tide conditions.

Anchorage

Radio communication is available on Channels 01, 18 and 67 for all the anchorages in Rakituma/Preservation Inlet.

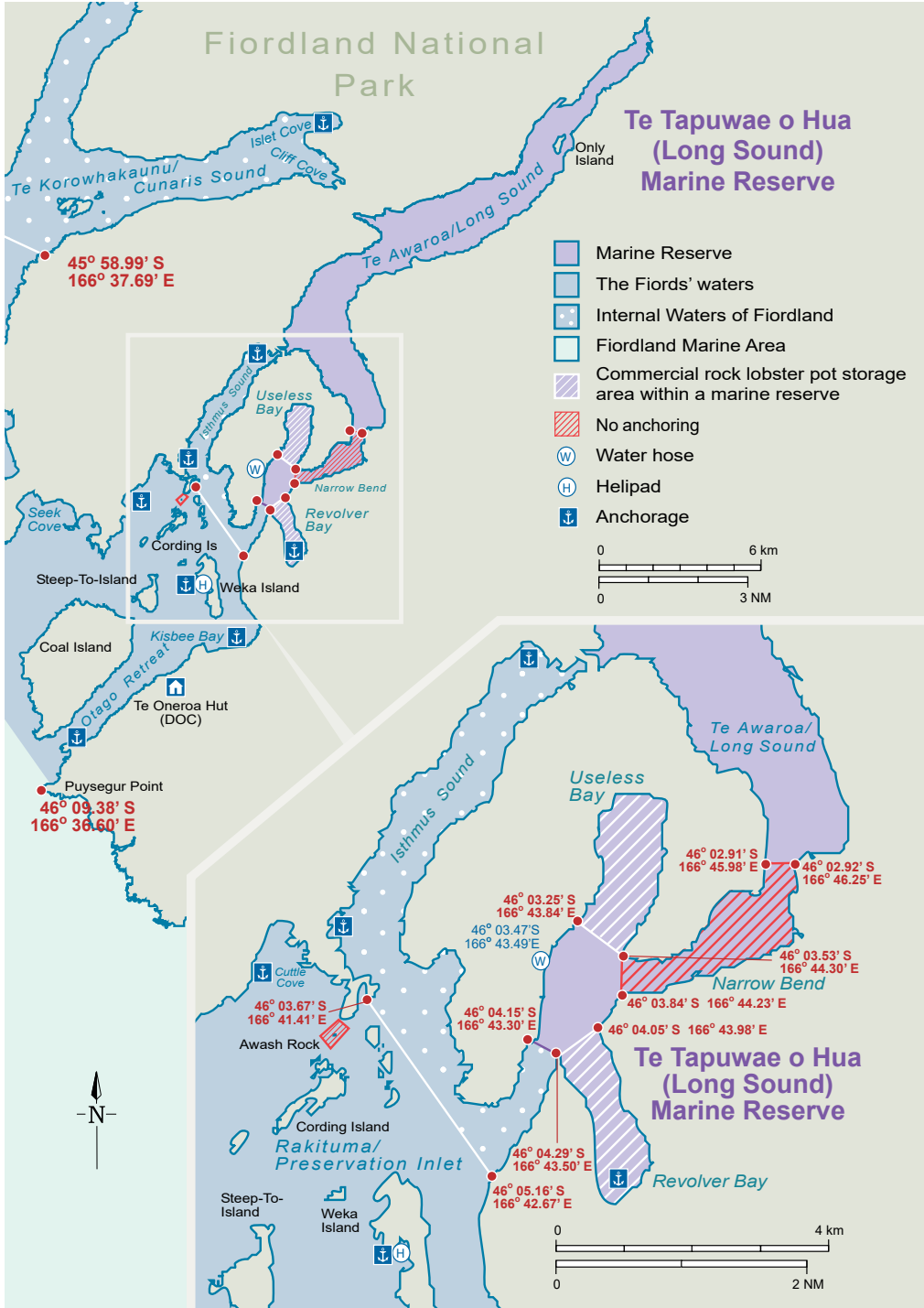

Rakituma/Preservation Inlet showing Te Tapuwae o Hua (Long Sound) Marine Reserve.

Isthmus Sound

This is an all-weather anchorage and should be approached with caution because of the shallow nature of the area. Use of a stern line, as shown on the map, is essential.

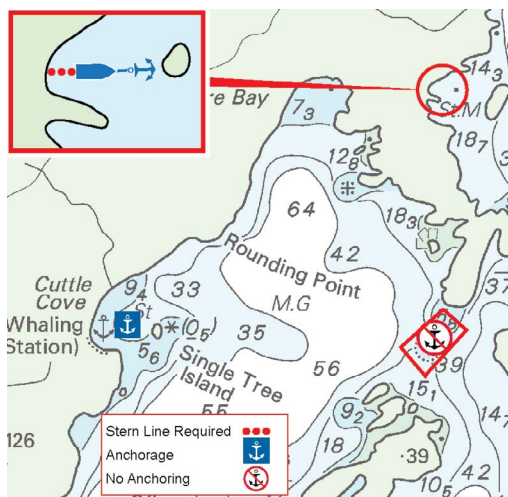

Isthmus Sound.

Otago Retreat

When approaching the anchorage, keep to the south-eastern side of the channel, as the area is very shallow. This anchorage is not recommended for overnight use but is used to access the track to the Puysegur Point lighthouse.

When approaching the boatshed landing in your dinghy, take extreme care through the narrow channel that was blasted out of the rocky reef during the construction of the lighthouse.

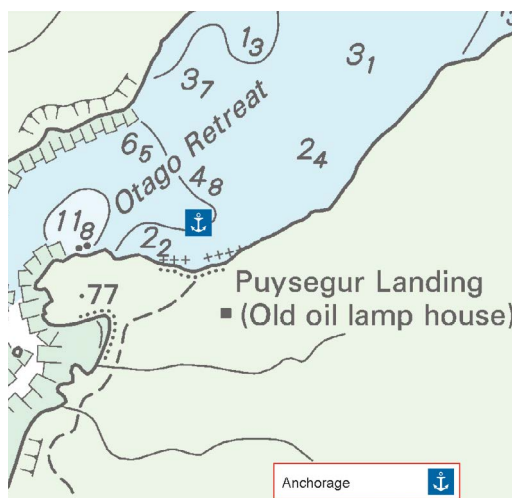

Otago Retreat.

Weka Island

This is a fair-weather anchorage and is not suitable in strong southwest conditions. Keep well over to the starboard side on entering the anchorage (as shown on the map), as there is a shallow rock reef that extends on the port side. There is a mooring in there.

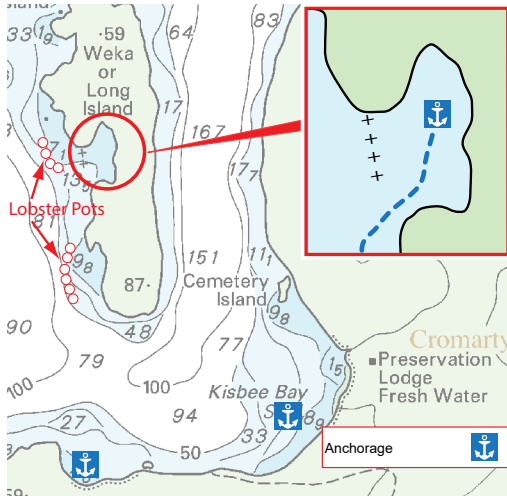

Weka Island.

Cuttle Cove

This is for moderate southwest to northwest conditions.

Powell's Beach, Kisbee Bay

This is a reasonable easterly anchorage as well as being good in light to moderate southwest conditions.

Preservation Lodge, Kisbee Bay

This is a fair-weather anchorage in moderate conditions.

Hut

There is one Department of Conservation hut in Rakituma/Preservation Inlet. The Te Oneroa A-frame hut is a basic bivvy that has two bunks. Kisbee Lodge, a private lodge, is situated in the former Cromarty settlement at Kisbee Bay.

There is a hut just inside the entrance at Otago retreat. Note that this is not a good anchorage, best for short stays only.

Marine Protected Areas

Te Tapuwae o Hua (Long Sound) Marine Reserve

The reserve includes the main Te Awaroa/Long Sound basin, the Narrows, and Revolver and Useless Bays. Te Awaroa/Long Sound (along with Te Hāpua/Sutherland Sound) is the most physically isolated basin in the Fiordland system, with a very narrow entrance and a shallow sill at the Narrows, which inhibits the exchange of deep water from the open coast. This underwater topography means that the entire reserve is sheltered from ocean swells and contains a constant and thick freshwater layer.

Research has shown that the rock-wall habitats in Te Awaroa/Long Sound contain unique suspension feeder communities, and species like the 11-armed starfish, whose genes are different to those elsewhere in the fiords. The Narrows contains the very delicate and internationally revered 'strawberry fields'. This is an area with large congregations of a strawberry holothurian (sea cucumber), along with high densities of stony corals, including red coral and soft coral sea pens on the soft sediment. The inner regions of Te Awaroa/Long Sound are home to high densities of lampshells, tube worms and rock crabs.

Two parts of Te Tapuwae o Hua (Long Sound) Marine Reserve – Revolver Bay and Useless Bay – are designated areas for commercial rock lobster holding and temporary pot storage.

The Narrows china shop – no-anchoring area

All anchoring is prohibited in the Narrows (Narrow Bend), from Adam Head to Sandy Point, to protect fragile marine life.

An abundance of sea pens occurs on the sand, with scallops located among them. Holothurians (in the 'strawberry fields'), red coral, and white brachiopods are also outstanding features of the Narrows.

Awash Rock – no-anchoring area

There is a small no-anchoring area around Awash Rock. The coordinates are:

- 46° 03'.86S, 166° 41'.12E
- 46° 03'.97S, 166° 40'.91E
- 46° 04'.07S, 166° 41'.01E
- 46° 03'.93S, 166° 41'.22E.

See **Isthmus Sound anchorage map**, page 133. This is a very fragile area and caution should be taken. There are many other (sandy) areas around the rock that should be used for anchoring purposes.



Strawberry holothurians. Photo: Steve Wing

References and contact information



Sources of information

The content of this book draws heavily on historical and local knowledge that has been contributed by Guardians (previous and current), tangata whenua, local operators, recreational enthusiasts, and officials from the partner agencies.

Where information has been sourced from websites, these have been provided in the text as suggestions for further information.

Kā Huru Manu (The Ngāi Tahu Cultural Mapping Project) is dedicated to recording and mapping the traditional Māori place names and associated histories in the Ngāi Tahu rohe (tribal area). The Ngāi Tahu Atlas is available online at www.kahurumanu.co.nz.

The following books were also consulted.

Annala JH. 1983. New Zealand rock lobsters: Biology and Fishery. *Fisheries Research Division Occasional Publication*. No. 42.

Allen J. 2009. *New Zealand Marine Radio Handbook: The User's Guide to VHF and SSB Marine Radio Stations*. Auckland: Mollymawk Publications.

Anderson A. 1986. Mahinga ika o te moana: Selection in the Pre-European Fish Catch of Southern New Zealand. In A Anderson (ed.) *Traditional Fishing in the Pacific*. Pacific Anthropological Records 37. Honolulu: Bishop Museum Press. pp 151–165.

Anderson A. 1998. *The Welcome of Strangers*. Dunedin: University of Otago Press.

Anderson A, Binney J, Harris A. 2014. *Tangata Whenua: An Illustrated History*. Bridget Williams Books.

Beaglehole J. 1961. *The Journals of Captain Cook on his Voyages of Discovery: Volume II, The Voyage of the Resolution and Adventure 1772–1775*. Cambridge: Cambridge University Press.

Begg A, Begg N. 1966. *Dusky Bay*. Christchurch: Whitcombe & Tombs.

Carbines G. 2009. Blue Cod Biology: Sticking to the facts. *New Zealand Fishing News* (November). 72–74.

Department of Lands and Survey. 1986. *The Story of Fiordland National Park*. Invercargill: Department of Lands & Survey.

Elvy D, Grindley R, Teirney L. 1997. *Management Plan for Paua 5 1992–97*. Dunedin: Ministry of Fisheries.

Guardians of Fiordland's Fisheries. 1999. *Beneath the Reflections. A Characterisation of Fiordland's Fisheries*. Invercargill: Guardians of Fiordland's Fisheries.

Guardians of Fiordland's Fisheries (Comp) Report held by the Ministry of Fisheries, Dunedin, New Zealand.

Hall-Jones J. 1979. *Fiordland Place Names*. Invercargill: Fiordland National Park Board.

Hall-Jones J. 2002. *The Fjords of Fiordland*. Invercargill: Craig Printing.

Hutchins L. 1998. *Making Waves*. Invercargill: Craig Printing.

McNab R. 1909. *Murihiku and the Southern Islands*. Invercargill: William Smith Printer.

Ministry for Primary Industries. 2013. *Clean Boats – Living Seas. A boatie's guide to marine biosecurity*. Wellington: Ministry for Primary Industries.

Peat N. 2007. *New Zealand's Fiord Heritage*. Invercargill: Department of Conservation.

Roberts W. 1913. *Place Names and Early History of Otago and Southland*. Christchurch: Kiwi Publishers.

Waitangi Tribunal. 1991. The Ngai Tahu Report 1991. Wellington: Waitangi Tribunal, Department of Justice.

Suggested further reading

- Beaglehole H. 2006. *Lighting the Coast: A history of New Zealand's coastal lighthouse system*. Christchurch, Canterbury University Press.
- Beattie JH. 1949. *The Māoris and Fiordland*. Dunedin: Otago Daily Times & Witness.
- Beattie JH. 2002. *Far Famed Fiordland*. Christchurch: Cadsonbury Publications.
- Begg A, Begg N. 1973. *Port Preservation*. Christchurch: Whitcombe & Tombs.
- Begg A, Begg N. 1979. *The World of John Boulton*. Christchurch: Whitcoulls.
- Carey P. 2020. *Tamatea Dusky Sound*. Nelson: Potton and Burton.
- Communicate New Zealand, Series 6401. Archives New Zealand/Te Rua Mahara o te Kawanatanga. Wellington Office.
- Department of Conservation. 2017. *Conserving Fiordland's biodiversity 1987–2015 – The challenges, the achievements, the knowledge / Te Tiaki i te Taiao ki Tu Rua o te moko Ngā wero, ngā haumāuiui, ngā mātauranga*. Te Anau District Office.
- Evison H. 1993. *Te Wai Pounamu: The Greenstone Island: A history of the southern Maori during the European colonisation of New Zealand*. Wellington: Aoraki Press.
- Evison H. 1997. *The Long Dispute*. Christchurch: Canterbury University Press.
- Gavalas M. 2007. *Landmarks of Fiordland, Southland and Stewart Island/Rakiura: Past and Present*. Auckland: Reed.
- Grady D. 1986. *Sealers and Whalers in New Zealand Waters*. Auckland: Reed Methuen, Auckland.
- Guardians of Fiordland's Fisheries and Marine Environment Inc. 2003. *Beneath the Reflections. Fiordland Marine Conservation Strategy*. Wellington: Ministry for the Environment.
- Hall-Jones J. 1990. *Fiordland Explored*. Invercargill: Craig Printing.
- Hall-Jones J. 1997. *Discover Fiordland*. Invercargill: Craig Printing.
- Hall-Jones J. 2000. *Milford Sound*. Invercargill: Craig Printing.
- Hill S, Hill J. 1987. *Richard Henry of Resolution Island*. Dunedin: John McIndoe and the New Zealand Wildlife Service.
- Howard G. 1969. *Heart of Fiordland*. Christchurch: Whitcombe & Tombs.
- Maritime New Zealand. 2023. *Radio handbook: Your guide to radio communication*. Fourth Edition.
- McClenaghan J. 1966. *Fiordland*. Wellington: Reed Publishing.
- McNab R. 1913. *The Old Whaling Days*. Auckland: Golden Press, Auckland.
- Peat N, Patrick B. 1996. *Wild Fiordland: Discovering the Natural History of a World Heritage Area*. Dunedin: University of Otago Press.
- Reed AW, Reed AH. 1951. *Captain Cook in New Zealand*. Wellington: Reed Publishing.
- Richards R. 1995. *The Foveaux Whaling Yarns of Yankee Jack*. Dunedin: Otago Heritage Books.
- Roberts W. 1910. *Maori Nomenclature: Early History of Otago*. Christchurch: Kiwi Publishing.
- Ryan P, Paulin C. 1998. *Fiordland Underwater. New Zealand's Hidden Wilderness*. Auckland: Exisle Publishing.
- Tau T, Anderson A (eds). 2008. *Ngai Tahu: A Migration History: the Carrington Text*. Wellington: Bridget Williams Books in association with Te Runanga o Ngai Tahu.

Recommended navigational charts

The following paper charts, produced by Land Information New Zealand | Toitū Te Whenua, are recommended for the Fiordland Marine Area.

Chart number	Chart name	Scale / New edition date
NZ 69	Stewart Island/Rakiura	1:200,000 / 2016
NZ 73	Abut Head to Milford Sound/Piopiotaahi	1:300,000 / 2019
NZ 76	Western approaches to Foveaux Strait	1:300,000 / 2016
NZ 681	Approaches to Bluff and Riverton/Aparima	1:100,000 / 2024
NZ 7621	Milford Sound/Piopiotaahi	1:25,000 / 2020
NZ 7622	Milford Sound/Piopiotaahi to Sutherland Sound	1:60,000 / 2016
NZ 7623	Hāwea/Bligh Sound to Taitetimu/Caswell Sound	1:60,000 / 2021
NZ 7624	Charles Sound to Dagg Sound	1:60,000 / 2021
NZ 7625	Te Awa-o-Tū/Thompson Sound and Doubtful Sound/Patea	1:25,000 / 2021
NZ 7653	Breaksea Sound and Dusky Sound	1:60,000 / 2021
NZ 7654	Chalky and Preservation Inlets	1:60,000 / 2016
NZ 7655	Te Puaithaha/Breaksea Sound	1:25,000 / 2021
NZ 7656	Tamatea/Dusky Sound	1:25,000 / 2021

Note: These references are correct at the date of publishing, according to www.linz.govt.nz/sea.

To purchase charts contact a Land Information New Zealand authorised reseller.

Contact information

Fiordland Marine Guardians

PO Box 213
Te Anau 9640
info@fmg.org.nz
www.fmg.org.nz

Department of Conservation

Te Anau District Office
Te Rua o-te-moko / Fiordland National
Park Visitor Centre
Lakefront Drive
PO Box 29
Te Anau 9640
Phone (03) 249 7924 or 24-hour hotline
on 0800 DOC HOT (0800 362 468)
www.doc.govt.nz

Environment Southland

Private Bag 90116
Invercargill 9840
Corner of North Road and Price Street Waikiwi
Invercargill 9810
Phone (03) 211 5115 or Southland area
24-hour pollution hotline on 0800 SOUTHLAND
(0800 76 88 45)
www.es.govt.nz

Ministry for the Environment

PO Box 10362
Wellington 6143
Phone (04) 439 7400
info@mfe.govt.nz
environment.govt.nz

Ministry for Primary Industries

Fisheries New Zealand – Fisheries Compliance
90 Tweed Street
Invercargill 9810
PO Box 1065
Invercargill 9840
Phone (03) 211 0060 or phone 0800 4 POACHER
(0800 476 224)
www.fish.govt.nz

Fisheries New Zealand

Inshore Fisheries South Team
73 Otaki Street
South Dunedin 9012
Phone (03) 466 3607

Biosecurity New Zealand

Pest Management, Marine Biosecurity
Charles Fergusson Building
34–38 Bowen Street
Pipitea
Wellington
Phone 0800 00 33 33
Or MPI 0800 80 99 66 to report suspected
marine pests or diseases.

Want another copy?

If you would like to purchase another copy of this guide please email:
info@fmg.org.nz.

An electronic copy of the guide can be downloaded at no cost from the Fiordland Marine Guardians' website: **www.fmg.org.nz/sites/default/files/2024-07/fiordland-by-sea.pdf**.

Since this guide was published there may have been changes to the regulations.

You can search for updates to regulations on the following websites:

Ministry for Primary Industries
www.mpi.govt.nz

Department of Conservation
www.doc.govt.nz

Environment Southland
www.es.govt.nz

Fiordland Marine Guardians
www.fmg.org.nz

The information contained in this guide is correct at the time of printing (July 2024) and is subject to change without notice. It is intended to be used as a guide only. The maps in the 'Fiord-by-fiord guide' section show the general locations of points of interest – they are not navigational charts.

This guide has been developed in partnership with:

